

Single and Multi-Bag Housings
Premium and Heavy-Duty Filter Bags

Bag Filtration Systems

**Solving Your Need
for More Filtration Efficiency**

With Smarter Technology



EATON

Powering Business Worldwide

In September 2005 Eaton Corporation acquired the industrial filtration business of Hayward Industries, Inc. The Hayward filtration business has been integrated into Eaton's Fluid Power Group as the Filtration Division. Eaton's Filtration Division is a global leader in products that include pipeline strainers, bag filtration systems, and gas/liquid separators for industrial and commercial customers worldwide. Primary markets include general industrial, petro-chemical, pharmaceutical, food and beverage, power utilities, marine, and water.

BAG FILTRATION SYSTEMS

Eaton's Bag Filter Housings and Filter Bags are used by industries around the world and are manufactured worldwide to global standards. Customers can choose from a complete line of single and multi-bag filter housings designed to meet the needs of the most demanding applications. The choice of single bag filter housings range from those suitable for exacting absolute filtration applications to high quality housings designed especially for cost sensitive applications... and everything in between. Multi-bag housings that accommodate up to 36 individual filter bags for flow rates of up to 4500 gpm are available in a number of different designs. Eaton offers a full range of Filter Bags...more than 1500 choices in all. From economical sewn filter bags for standard applications to welded, multilayered bags for demanding applications. Eaton is helping customers reduce process costs through its development of a unique range of proprietary filter bags and elements that offer a compelling, cost effective alternative to more expensive cartridge filter systems.

PIPELINE STRAINERS

Eaton's Pipeline Strainers are used by industrial and commercial customers to protect their process piping equipment by removing debris from the liquid that flows through pipelines. Products include automatic self-cleaning strainers as well as manual, duplex, simplex, and Y strainers. Both cast and fabricated type strainers are made in standard configurations

to meet the needs of most applications. For unique, complex, or specialized applications, a Pipeline Strainer can be designed and manufactured to meet the exact requirements of the application with no compromises. Eaton offers Pipeline Strainers in sizes from a tiny 1/4" up to a huge 48" pipeline size.

GAS/LIQUID SEPARATORS

Eaton's Gas/Liquid Separators protect expensive system components, such as turbines, by removing potentially damaging moisture and particulate matter from air, gas, and steam lines. Dozens of different models, both cast and fabricated, are available to meet customers' needs worldwide.

COMMITMENT TO GLOBAL MARKETS

Eaton's Bag Filtration Systems, Pipeline Strainers, and Gas/Liquid Separators have each been developed into a global product line which is manufactured worldwide in multiple locations to a common design standard yet in compliance with local code requirements. This lets Eaton customers worldwide choose the pipeline strainer, bag filter, or gas/liquid separator that meets their exact requirements without compromise. Local sales and technical support specialists are always available to review the needs of an application with the customer and recommend specific solutions. This local support extends from initial purchase, to installation, through start-up and beyond.

EATON CORPORATION

Eaton is a diversified industrial manufacturer with 2004 sales of \$9.8 billion. Eaton is a global leader in electrical systems and components for power quality, distribution, and control; fluid power systems and services for industrial, mobile, and aircraft equipment; intelligent truck drivetrain systems for safety and fuel economy; and automotive engine air management systems, powertrain solutions, and specialty controls for performance, fuel economy, and safety. Eaton has 59,000 employees and sells products to customers in more than 125 countries. For more information, visit www.eaton.com.

QUALIFICATIONS

This brochure details what is now regarded as the most comprehensive, innovative line of Filter Housings and Accessories available on the market. Over recent years we have introduced new concepts to Filter Housing design encompassing the revolutionary QIC-LOCK™ quick opening cover-lid mechanism (see page 12/13) greatly reducing change-out times and a tangential outlet which lowers housing height making it easier to access the filter bags.

One of Eaton's greatest achievements is the development and implementation of a single global product line manufactured worldwide in multiple locations to a common design in compliance with local code requirements:

- In Europe, Asia-Pacific and South America Eaton is fully qualified to provide pressure housings of Category I-IV under the Pressure Equipment Directive (PED) (97/23/EC) which came into effect May 29, 2002. Housings are manufactured to Design Code AD 2000-Merkblätter, the Notified body is TÜV Nord, Conformity Assessment up to Module H1 and G.
- In North America, South America and Asia, Eaton is fully qualified to provide the same range of housings according to ASME. Canadian registration numbers, CRN, are also available.

In every location, Eaton Sales and Technical Support specialists can review the needs of an installation and recommend the right combination of hazard category and housing design to meet any need.

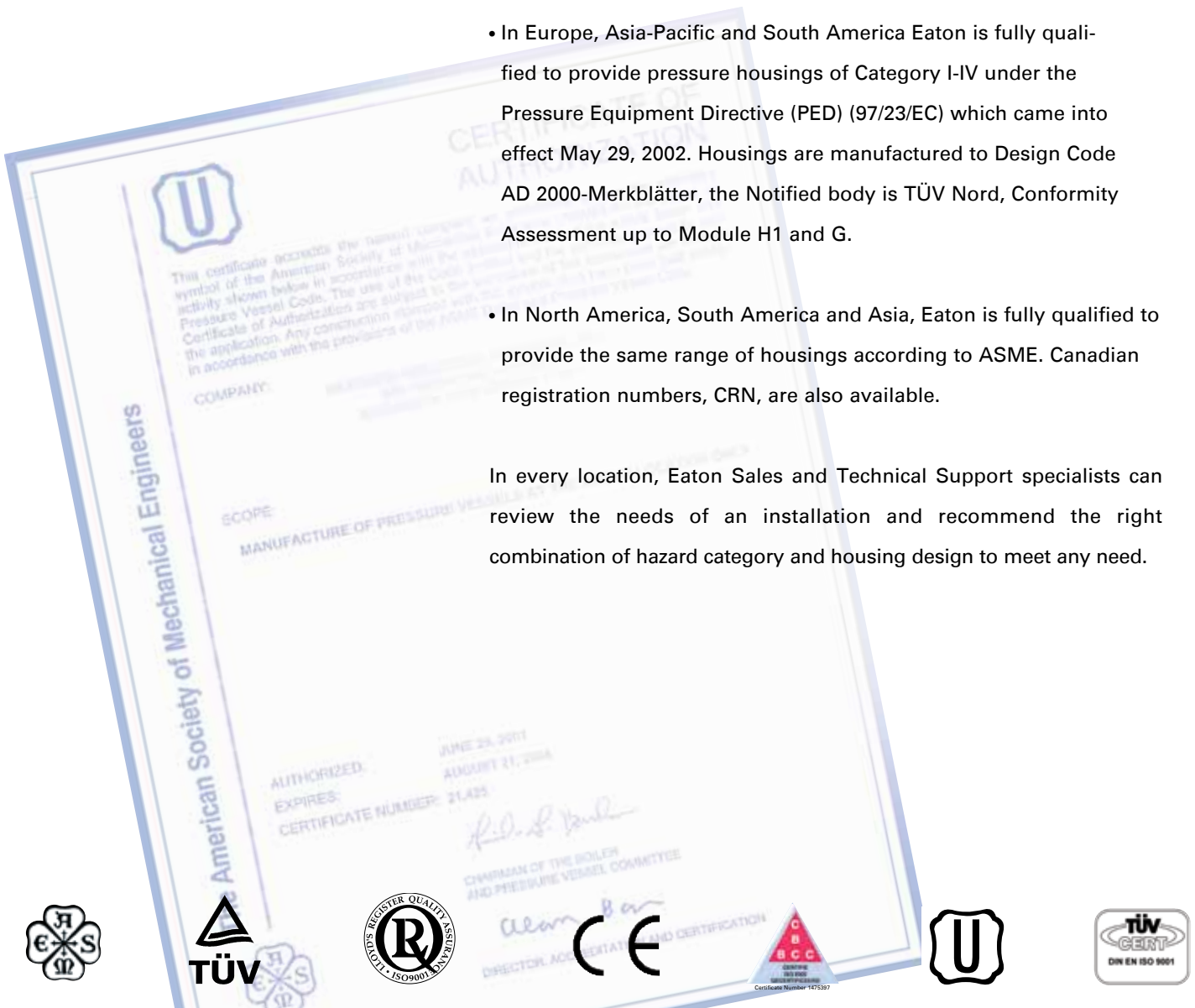

TECHNICAL DATA

SERIES	Type*	No. Of Bags		Bag Size	Max. Flow 2 GPM	Material 1	Max. Allowable Pressure		Housing Volume		Inlet	Outlet Connection	Type	Vent 4	Dimensions In Inches					
		PSI	°F				GAL	LBS	IN	A					B	C	D	E	F	
MAXILINE VMBF SE	VMBF-0402-AB10-040A-UT-11SE	4	2	400	SS	150	250	69	484	4"	Flanged	1"	6.00	20.00	10.50	22.00	15.75	68.00		
	VMBF-0602-AB10-060A-UT-11SE	6	2	900	SS	150	250	139	983	6"	Flanged	1"	7.25	20.00	13.00	31.50	20.75	80.00		
	VMBF-0802-AB10-080A-UT-11SE	8	2	1750	SS	150	250	141	1023	8"	Flanged	1"	8.25	19.00	12.80	31.50	20.50	80.00		
MAXILINE MBF HE	MBF-0302-AB10-030A-UT-11HE	3	2	230	SS or CS	150	250	40	245	3"	Flanged	1"	6.00	22.50	6.40	18.00	12.75	60.00		
	MBF-0402-AB10-040A-UT-11HE	4	2	400	SS or CS	150	250	69	380	4"	Flanged	1"	6.00	22.20	7.40	24.00	16.00	68.40		
	MBF-0602-AB10-060A-UT-11HE	6	2	900	SS or CS	150	250	90	440	6"	Flanged	1"	7.50	19.50	9.03	24.00	16.50	68.80		
	MBF-0802-AB10-080A-UT-11HE	8	2	1750	SS or CS	150	250	116	644	8"	Flanged	1"	8.25	19.00	6.48	30.00	20.50	79.50		
MAXILINE MBF HD	MBF-0302-AB10-030A-UT-11HD	3	2	230	SS or CS	150	250	40	255	3"	Flanged	1"	6.00	22.50	6.40	18.00	12.75	66.00		
	MBF-0402-AB10-040A-UT-11HD	4	2	400	SS or CS	150	250	54	390	4"	Flanged	1"	6.00	22.20	7.80	24.00	16.00	68.00		
	MBF-0602-AB10-060A-UT-11HD	6	2	900	SS or CS	150	250	95	460	6"	Flanged	1"	7.00	20.00	9.80	26.00	18.50	68.00		
	MBF-0802-AB10-080A-UT-11HD	8	2	1750	SS or CS	150	250	140	655	8"	Flanged	1"	8.25	19.00	10.78	30.00	20.50	66.00		
	MBF-1002-AB10-100A-UT-11HD	10	2	2600	SS or CS	150	250	215	1400	10"	Flanged	1"	10.00	17.00	13.30	36.00	24.50	70.00		
	MBF-1202-AB10-100A-UT-11HD	12	2	2600	SS or CS	150	250	245	1500	10"	Flanged	1"	10.00	17.00	13.80	38.00	24.50	72.00		
	MBF-1402-AB10-100A-UT-11HD	14	2	2600	SS or CS	150	250	311	1800	10"	Flanged	1"	11.50	20.00	11.81	42.00	28.00	76.00		
	MBF-1602-AB10-120A-UT-11HD	16	2	3500	SS or CS	150	250	317	1875	12"	Flanged	1"	11.50	20.00	11.81	42.00	28.00	76.00		
	MBF-1802-AB10-120A-UT-11HD	18	2	3500	SS or CS	150	250	446	2420	12"	Flanged	1"	12.50	22.00	10.69	48.00	31.00	88.00		
	MBF-2002-AB10-140A-UT-11HD	20	2	4500	SS or CS	150	250	454	2505	14"	Flanged	1"	12.50	22.00	10.69	48.00	31.00	88.00		
	MBF-2202-AB10-140A-UT-11HD	22	2	4500	SS or CS	150	250	570	2730	14"	Flanged	1"	12.50	22.00	13.44	52.00	33.00	92.00		
	MBF-2402-AB10-140A-UT-11HD	24	2	4500	SS or CS	150	250	570	2800	14"	Flanged	1"	12.50	22.00	13.44	52.00	33.00	92.00		
TOPLINE	TBF-0101-AB10-020A	1	1	90	SS or CS	150	400	3.5	80	2"	Flanged	1/4"	17.70	15.00	1.93	8.62	12.08	53.50		
	TBF-0102-AB10-020A	1	2	180	SS or CS	150	400	7.25	93	2"	Flanged	1/4"	17.70	31.00	1.93	8.62	12.08	84.25		
	TBF-0102-AB10-020R-M32B0	1	2	180	SS	150	400	7.25	93	2"	Tri-Clamp	1/4"	15.80	32.78	1.93	8.62	12.83	84.25		
SIDELINE	SBF-0101-AB10-020A	1	1	90	SS	150	400	4.75	84	2"	Flanged	1/4"	17.70	19.50	3.15	8.62	8.66	54.70		
	SBF-0101-AB10-030A	1	1	90	SS	150	400	4.75	84	3"	Flanged	1/4"	17.70	19.50	3.15	8.62	8.66	54.70		
	SBF-0102-AB10-020A	1	2	180	SS	150	400	8.5	102	2"	Flanged	1/4"	17.70	35.00	3.15	8.62	8.66	85.50		
	SBF-0102-AB10-030A	1	2	180	SS	150	400	8.5	102	3"	Flanged	1/4"	17.70	35.00	3.15	8.62	8.66	85.50		
	SBF-0103-AB21-015N	1	3	25	SS	300	225	0.5	26	1 1/2"	NPT	1/4"	na	11.77	2.95	4.50	3.50	21.80		
SBF-0104-AB21-015N	1	4	50	SS	300	225	0.7	29	1 1/2"	NPT	1/4"	na	17.87	2.95	4.50	3.50	33.90			
DUOLINE	TOPLINE	2	2	180	SS or CS	150	250	16	240	2"	Flanged	1/4"	17.70	24.50	1.93	8.62	37.45	84.25		
	SIDELINE	2	2	180	SS	150	250	16	300	2"	Flanged	1/4"	17.70	27.50	3.15	8.62	30.82	85.50		
	SIDELINE	2	2	180	SS	150	250	17	330	3"	Flanged	1/4"	17.70	27.50	3.15	8.62	33.32	85.50		
	FLOWLINE	2	2	180	SS or CS	150	250	15	200	2"	Flanged	1/4"	17.70	28.44	3.34	7.68	37.45	85.50		
MODULINE	TOPLINE	1+1	2	360	SS or CS	150	250	16	230	2"	Flanged	1/4"	17.70	24.50	1.93	8.62	34.32	84.25		
	SIDELINE	1+1	2	360	SS	150	250	16	230	2"	Flanged	1/4"	17.70	27.50	3.15	8.62	27.44	85.50		
	SIDELINE	1+1	2	360	SS	150	250	17	300	3"	Flanged	1/4"	17.70	27.00	3.15	8.62	29.70	85.50		
	FLOWLINE	1+1	2	360	SS or CS	150	250	15	170	2"	Flanged	1/4"	17.70	28.44	3.34	7.68	26.64	85.50		
POLYLINE	PBF-0101-PO10-020A	1	1	50	PPL	150	70	6.6	55	2"	Flanged	1/4"	3.26	20.75	3.38	10.35	8.50	60.00		
	PBF-0101-PO10-020N	1	1	50	PPL	150	70	6.6	51	2"	NPT	1/4"	3.26	20.75	3.38	10.35	6.14	60.00		
	PBF-0102-PO10-020A	1	2	100	PPL	150	70	9.5	68	2"	Flanged	1/4"	3.26	36.75	3.38	10.35	8.50	76.00		
	PBF-0102-PO10-020N	1	2	100	PPL	150	70	9.5	64	2"	NPT	1/4"	3.26	36.75	3.38	10.35	6.14	76.00		
	PBF-0102-PF07-020A	1	2	100	PVDF	100	80	9.5	100	2"	Flanged	1/4"	3.26	36.00	3.88	10.35	8.50	75.25		
	D-PBF-0101-PO10-020A	1+1	1	50	PPL/CPVC	150	70	14.5	162	2"	Flanged	1/4"	6.10	39.04	3.88	10.35	30.00	75.10		
	D-PBF-0101-PO10-020N	1+1	2	100	PPL/CPVC	150	70	20.6	190	2"	Flanged	1/4"	6.10	55.04	3.88	10.35	30.00	91.10		
FLOWLINE	FBF-0101-AB10-020A	1	1	90	SS or CS	150	250	4	30	2"	Flanged	1/4"	17.70	20.75	3.34	7.68	6.70	54.90		
	FBF-0101-AB10-020N	1	1	90	SS or CS	150	250	4	30	2"	NPT	1/4"	17.70	19.64	3.34	7.68	5.37	54.90		
	FBF-0102-AB10-020A	1	2	180	SS or CS	150	250	7	43	2	Flanged	1/4"	17.70	36.31	3.34	7.68	6.70	85.70		
	FBF-0102-AB10-020N	1	2	180	SS or CS	150	250	7	43	2"	NPT	1/4"	17.70	35.19	3.34	7.68	5.37	85.70		
ECOLINE	EBF-0101-AB10-020N	1	1	90	SS	100	250	4	25	2"	NPT	1/4"	na	19.64	3.24	7.68	5.37	37.00		
	EBF-0102-AB10-020N	1	2	180	SS	100	250	7	38	2"	NPT	1/4"	na	35.19	3.24	7.68	5.37	68.00		
	EBF-0103-AB10-015N	1	3	25	SS	150	250	0.5	9	1 1/2"	NPT	1/4"	na	11.77	2.78	4.50	3.50	22.45		
	EBF-0104-AB10-015N	1	4	50	SS	150	250	0.7	11	1 1/2"	NPT	1/4"	na	17.87	2.78	4.50	3.50	33.84		

* Type number is for stainless steel construction. Change AB to CS for carbon steel. ** Depending on seal material

Product Codes							
D	MBF	04	02	AC	10	050	D
D-DUOLINE	VMBF-MAXILINE	No. of bags	Bag Size	Material	Pressure rating	Connection Size	Connection Type
M-MODULINE	MBF-MAXILINE	01, 02,	01-short 7"	AB-SS316	10-150 psi	050-1/2"	A-ANSI Flange
	TBF-TOPLINE	04, 08,	02-long 7"	CS-Carbon Steel	21-300 psi	010-1"	N-NPT Female Thread
	SBF-SIDELINE	12, 16,	03-short 4"	PO-Polypropylene		012-1 1/4"	
	PBF-POLYLINE	20, 24	04-long 4"	PF-PVDF		015-1 1/2"	
	FBF-FLOWLINE					020-2"	
	EBF-ECOLINE					Up to 140-14"	

1) SS = Austenitic Stainless Steel SS 316 and CF8M or better
 2) Maximum theoretical flow based on water viscosity, bag specific
 3) Dimensions for reference only and approximate. Exact dimensions for installation purposes available on request.
 4) For details, see available product specific data sheet

APPLICATIONS

	ECOLINE	FLOWLINE	SIDELINE	TOPLINE	MAXILINE			POLYLINE	DUOLINE	MODULINE
					HD	HE	SE			
Coarse filtration >500 µm	■	■	■		■	■	■	■	■	■
Medium filtration >10 µm			■	■	■	■	■	■		
Fine filtration <10 µm				■	■	■	■			
Pre-filtration	■	■	■		■	■	■	■	■	■
Safety filtration			■	■	■	■	■		■	■
High volume					■	■	■			■
Batch filtration		■	■	■			■	■		
Circuit filtration			■	■	■	■	■	■	■	
Continuous filtration									■	
Solvents, Paints			■	■	■	■	■			
Fats and Oils			■	■	■	■	■		■	■
Catalyst, Activated Carbon				■						
Acids, Bases			■	■	■	■	■	■	■	
Petrochemicals			■	■	■	■	■		■	■
Water, Waste Water	■	■	■	■	■	■	■	■	■	■
Chemical Industry			■	■	■	■	■	■	■	■
Pharmaceuticals				■						
Metal Cleaning	■	■	■		■	■	■			■
Automotive				■	■	■	■			■
Electronics				■				■		
Food and Beverage			■	■						
Paint and Laquer			■	■	■	■	■		■	
Water Treatment	■	■	■	■	■	■	■	■	■	■
Galvanic Industry			■	■				■		



Automotive



Metal Parts Washing



**Resins, Polymers
Inks, Dispersions**



Chemical Industry



Petrochemicals



Water Treatment



**Electronics
Semiconductor**



**Paint and
Lacquer**



Galvanic Industry



**Food and
Beverage**



Pharmaceuticals



Environmental

TABLE OF CONTENTS

Applications 10



12 QIC-LOCK™ Concept

Multi-Bag housing with Open and Close cycles of less than 30 seconds!

QIC-LOCK™ MAXILINE™ VMBF SE

The user friendly, cost effective bag filter housing for high volume applications and processes demanding frequent bag change-out. Ideal for batch process runs and safety filtration.



14



15 MAXILINE™ MBF HE

The user friendly, perfect sealing bag filter housing for safe filtration and minimized product loss. Ideal for batch processes which demand the highest quality of filtration.

MAXILINE™ MBF HD

The user friendly, perfect sealing bag filter housing for safe filtration and minimized product loss. Features an economic davit cover design.



16



17 Custom Designed Housings

Eaton bag filter housings are designed to accommodate a wide range of possible standard modifications.

TOPLINE™ Filter Housings

The best filter housing for the most demanding applications.

18

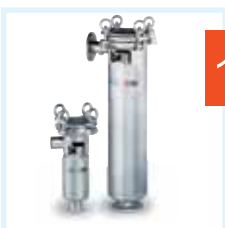

19 SIDELINE™ Filter Housings

Mid-priced filter housings for most applications.

FILTER HOUSINGS

DUOLINE™ / MODULINE™ / TOPLINE™ Dual Filter Housings

Discover the flexibility of using multiple housings together as part of a system.

20



21

POLYLINE™ Filter Housings

All-plastic, rugged Polypropylene or PVDF construction for superior corrosion resistance.



FLOWLINE™ Filter Housings

Versatile, heavy-duty but cost-effective filter housings.

22



23

ECOLINE™ Filter Housings

Light-weight, economical filter housings.



EATON Filter Housing Accessories

Original Eaton Accessories, Consumables and Spare Parts for safety and reliability.

24



50

Technical Information



52

Pipeline Strainers & Gas Liquid Separators

Overview of the entire Eaton pipeline strainer and gas/liquid separator lines.



TABLE OF CONTENTS

10 Applications

An overview of some of the thousands of filtration processes that can be improved and made more efficient or cost effective with Eaton High Performance Filter Bags.



26 What's Behind Every Eaton Precision Filter Bag

A quick look at what makes an Eaton high performance filter bag and the technology behind it.

PROGAF™ Filter Bags

30



A revolution in filter bags. PROGAF™ combines a high-efficiency media with a high capacity pre-filter for effective particulate removal down to the submicron level.



34 ACCUGAF™ Filter Bags

Highly efficient filter bags that have an extremely high particle retention efficiency. Applications that require this high filtration efficiency can now take advantage of bag filtration with Eaton's ACCUGAF™.

LOFCLEAR™ Filter Bags

36



Highly efficient filter bags with a special multi-layer construction that results in a better than nominal efficiency in demanding applications.



38 DURAGAF™ Filter Bags

Features increased media thickness with finer fibers for high pore volume. Reduced time between bag changings improves operating efficiencies and reduces operating costs. Discover how DURAGAF™ can work better in your application.

FILTER BAGS

CLEARGAF™ Filter Bags 40

For food, beverage, and pharmaceutical applications, most Eaton filter bags can be manufactured, packaged, and stored to meet EEC and FDA requirements.



41 BANDSEAL™

Tie-on filter bags for filtration without a vessel.



SENTINEL® 42

All-welded construction bags for higher filtration efficiency. Unique ring seal for worry-free sealing assurance.



43 SNAP-RING®

Sewn construction filter bag for less demanding applications.



HAYFLOW™ 44

Eaton's revolutionary new filter element.



50 Technical Information



Pipeline Strainers & Gas Liquid Separators

Overview of the entire Eaton Pipeline Strainer line and gas/liquid separator lines.

52



APPLICATIONS

Typical Applications for Eaton High Performance Filter Bags

Automotive

Filtration of pretreatment bath, filtration of E-Coat, topcoat and clearcoat, primer, paint ring line filters, parts cleaning fluids, drawing compounds, lubricants, metal working fluids and pump intake filters.



Chemical

Catalyst recovery, removal of pipe scale, polishing of aqueous process fluids, alkalis, acids and solvents, filtration of emulsions and dispersions, gel removal from resins. Activated carbon or catalyst removal in the fine chemicals industry is a typical example of a demanding application in chemical processing. Eaton Filter Bags meet these application requirements for high filtration efficiency coupled with long service life and reliability.



Electronics

Wafer and chip processing, electronic etching baths, photo-chemical polishing and high-purity water filtration and prefiltration of various membrane filtration processes to improve their cost effectiveness. Eaton Filter Bags demonstrate the required purity, efficiency and consistent performance.



Food and Beverage

Polishing filtration of wine, spirits and beer, removal of particles from edible oils, removal of carbon black from cellulose, slime removal in gelatins, liquid sugar, thick juice, corn syrup polishing, starch processing, milk processing and soft drinks. Many Eaton Filter Bags conform to FDA and even EEC food processing standards and can meet the unique and varied demands of these applications.



Metal Working

Filtration of hydraulic oil, pretreatment system filtration, precious metal recovery, metal working fluids, and drawing compounds. Parts cleaning machines use our filter bags for minimizing residual dirt on parts.



Petrochemicals

Filtration of lube oils, fuel additives, enhanced oil recovery, filtration of amine solutions, filtration of glycol fluids, gas purification processes, distillation and cracking processes, amine washers, off-shore filter stations, oil drilling and injection fluids.



Paint and Lacquer

Removal of agglomerates, removal of paint coagulates, solvent filtration, removal of storage contaminants, filling lines, and paint mixing lines, monomer purification.



Pharmaceutical

Recovery of expensive active ingredients, catalyst recovery, active carbon purification and removal, filtration of gelatins, hormones, vitamin extracts, polishing of herbal mixtures, protein removal from plasma, filtration of saline solutions.



Resins, Plastics, Inks and Coatings

Oil and polymer filtration, dispersions, polymerization batches, resins for can coatings, plastics compounding, printing ink, plastics processing, paper coatings, high purity ink-jet fluid filtration.



Water Treatment

Well water filtration, water treatment plants, silt removal, pipe scale removal, sand and algae removal from sea water, ion exchange resin recovery, calcium deposit removal, filtration of chemicals used for water treatment, dust removal from cooling tower installations. Surface water filtration is an area traditionally dominated by cartridge filtration. Now, the high efficiency and long life of Eaton High Performance Filter Bags are a cost-effective alternative to expensive cartridges.



User friendly

Economical

**Fast · Simple · Efficient · Economical · Safe · User Friendly · Durable
Low Maintenance · Cost Effective · Approved Design · High Productivity**

Terms that reflect bag filter user expectations in the modern day production environment.

Multi-Bag/MAXILINE™ Housing Open and Close cycles in less than 30 seconds!

The revolutionary QIC-LOCK™ opening mechanism answers all the demands of Bag Filtration users working in an environment where productivity and safety are the key priorities. Years of field-based experience on earlier designs such as the V-clamp “toggle” closure followed by the “ratchet” system have all proven the requirement for benefits of rapid opening mechanisms.

- QIC-LOCK opening mechanism is safe to use, an interlock prevents opening until the housing is entirely vented.
- QIC-LOCK opening mechanism is simple and fast to operate. Standing in 1 position, the operator can rotate the hand-wheel and open the cover, there is no requirement to have full movement and access around the housing or the use of any tools as with conventional bolted closures.
- QIC-LOCK opening mechanism has a rugged design, precision machining assures long-life and repeatable operation, and a special coating protects the spindle surface from wear and corrosion. The design is approved for all pressure housing design codes.

QIC-LOCK opening mechanism doesn't just make life easier for operators; there are significant cost benefits to be realized with greatly reduced down times and lower maintenance costs.

Safe



1 Filter element change necessary, opening the safety interlock ensures simultaneous pressure relief



2 Rotation of the spindle using a hand-wheel opens the V-clamp into the end position



3 Opening the cover aided by spring assisted mechanism



4 Filter element change



5 Closing of the cover



6 Closing of the V-clamp by rotation of the spindle



7 Closing of the safety interlock, housing is ready to go on-line!

Easy

Efficient

Effective

Fast

MAXILINE™ VMBF SE

QIC-LOCK™ MAXILINE™ VMBF SE

The user friendly, cost effective bag filter housing for high volume applications and processes demanding frequent bag change-out. Ideal for batch process runs and high dirt load applications.



- QIC-LOCK rapid opening mechanism ensures simple, operator friendly and safe operation with minimal downtime to increase productivity and decrease running costs.
- Unique 3-point hold down or bayonet fittings ensure high quality of seal between each filter bag and housing body. Special tool (supplied) ensures simple effective operation.
- A counter-balanced spring assisted cover-lifting mechanism balances the cover perfectly giving it a weightless feel. Opening and closing of the cover with the "little finger" is a reality.
- Positive O-ring sealing offers easy and safe operation.
- Side inlet and bottom outlet provides easy and full drainage, tangential outlet option available to reduce housing height.
- Available in Type 304 or 316 stainless steel for high corrosion resistance.
- Housing volume is optimized to minimize product loss.
- 6 standard sizes with 4 through to 24 bag housings available (size 02).

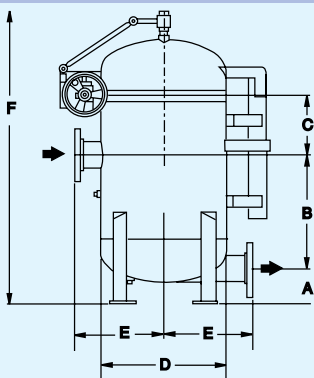

These value added features:

- QIC-LOCK spindle mechanism
- Automatic safety interlock for venting housing
- Low profile design with tangential inlet/outlet.
- Spring assisted cover lifter

See page 5 for dimensions.

Give these benefits

- Operator friendly, simple, fast bag change-out. Ideal for processes requiring frequent bag changes such as batch processes.
- Cover cannot be opened if housing is under pressure.
- Reduces housing height to make bag changing easier. No need for ladders, stools or catwalks.
- Quick, easy opening of even the largest size covers by a single person.

MAXILINE™ MBF HE

MAXILINE™ MBF HE

The user friendly, cost effective bag filter housing for high volume, multiple applications and processes.

- The bag filter housing is designed with a proven swing eye-bolt or segment clamp closure mechanism.
- Unique 3-point hold down or bayonet fittings ensure high quality of seal between each filter bag and housing body. Special tool (supplied) ensures simple, effective operation.
- A counter-balanced spring assisted cover-lifter balances the cover perfectly giving it a weightless feel. Opening and closing of the cover with the "little finger" is a reality.
- Positive O-ring sealing offers easy and safe operation.
- Side inlet and bottom outlet provides easy and full drainage, tangential outlet option available to reduce housing height.
- Available in carbon steel or Type 304 or 316 stainless steel for high corrosion resistance.
- Housing volume is optimized to minimize product loss.
- 6 standard sizes with 4 through to 24 bag housings available (size 02).



These value added features:

Low profile design with tangential inlet/outlet

Positive, 3-point bag hold downs

Spring assisted cover lifter

Eye-bolt cover closure

Give these benefits

Reduces housing height to make bag changing easier. No need for ladders, stools or catwalks.

Individual, bag sealing for by-pass free filtration.

Quick, easy opening and closing of even the largest size covers.

Rugged, proven design, easy to use.

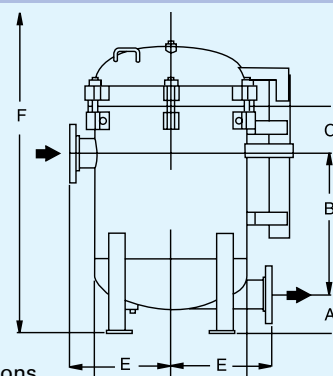

See page 5 for dimensions.

MAXILINE™ MBF HD

MAXILINE™ MBF HD

The MAXILINE HD multi-bag filter housing features a cost effective, handwheel operated, davit cover. Loosen the swing bolts, turn the davit handwheel and swing the cover aside.



- Standard ASME "U" Code Stamp.
- Tapered, electro-polished stainless steel perforated baskets.
- Unique 3-point hold-down or bayonet fittings ensure high quality of seal between each filter bag and housing body. A special tool (supplied) ensures simple, effective operation.
- Rugged, simple handwheel-operated davit cover makes the HD perfect for cost sensitive applications.
- Hydraulic-assist davit cover is available as an option.
- Positive O-ring sealing provides easy, reliable operation.
- Available in carbon steel and Type 304 stainless steel for high corrosion resistance.
- 7 standard sizes with 3 through to 24 bag housings are available for size 02 filter bags.



These value added features:

Give these benefits

Hand wheel operated davit cover

Rugged, reliable and very cost effective.

Positive bag hold downs

Perfect bag to housing sealing for no by-pass

Up to 24 bags per housing

Can handle very high flow rate / high dirt load applications

Positive O ring seal

No external leakage

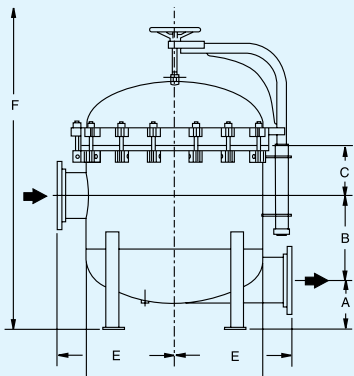

See page 5 for dimensions.

Custom Designed Housings

Eaton bag filter housings are designed to accommodate a wide range of possible standard modifications

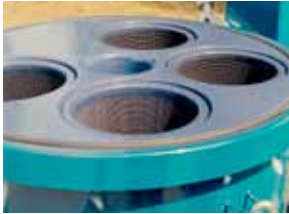

EPOXY coating

Material of construction optimized for Chemical and Temperature compatibility:

Housing - Carbon steel, Stainless steel in various grades, Hastelloy®, Polypropylene, PVDF, PVC

Coatings - PTFE/FEP, ECTFE, Polyurethane and Epoxy

Sealings - A wide range of Gaskets and O-rings are available

Process Operating Conditions:

Pressure/Temperature - Depending on housing size, up to 1000 psi/750°F, Heating jackets with 200 psi/750°F

Flow rates - Up to 4400 gpm



QIC-LOCK™

Cover Closure/Lifting Mechanisms:

Closure - QIC-LOCK spindle, T-bolt, Swing eye-bolts, Hex-nuts, Stud-bolts

Lifting - Spring, counterbalanced, hydraulic and hand wheel davit



Surface Finish/Connections:

Surface - Glass-beaded, Sand Blasted-painted, Electro-polished, Hand-polished, Acid-pickled, Coated (see above)

Connections - Standardized flanges and threads (DIN, NPT, ANSI, BSP), Sanitary (Tri-clamp, Milk pipe, IDF, RJT and other sterile types)



Approvals and Design Codes:

ISO 9001 : 2000 Certification

PED (Pressure Equipment Directive 97/23/EC)

AD 2000-Merkblätter, EN 13445, Stoomwezen, CODAP, BS5500, ASME VIII Div 1

Notified body: TÜV Nord CE 0035

Modules: Up to module H1 and G

SVTI

ASME (American Society of Mechanical Engineers)

U stamp and UM stamp, CRN (Canadian Registration Number)

Skid Mounting and Mobiles:

Skids - In-house engineering capability to couple multiple housings and or integrated control systems

Mobiles - Application specific mobile units e.g. Wine Pallet



Wine Pallet

TOPLINE™

TOPLINE™ Filter Housings

The best filter housing for the most demanding applications.



- A TOPLINE is the finest single bag filter housing available. From its high-performance design to its heavy duty investment-cast components, everything about TOPLINE is simply the best.
- Side inlet, flow through the top design results in a minimum headroom of unfiltered liquid for easy bag change-out as well as providing optimum sealing of the filter bag.
- For filter bags sizes 01 and 02.
- Available in carbon steel or Type 304 or 316 stainless steel construction for high corrosion resistance
- A smooth, bead-blasted finish, coupled with a minimum 2-weld design, makes it easy to completely clean the interior of the TOPLINE housing.
- All TOPLINE housings come with an exclusive Five Year Warranty and the ASME code UM stamp.
- TOPLINE housings... for applications too demanding for ordinary bag filters.

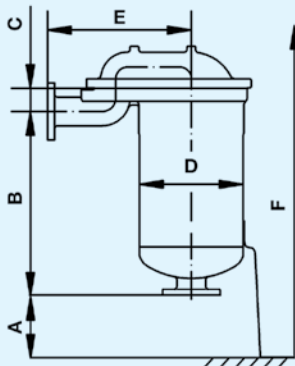

These value added features:

Top inlet with liquid flow through the cover.

Cover seals directly onto the filter bag

Five year warranty

Adjustable mounting legs

See page 5 for dimensions.

Give these benefits

Reduced headroom for unfiltered liquid makes bag change-out quick and easy.

Perfect sealing for the finest micron by-pass free filtration applications.

Years of trouble and maintenance free service.

Easier installation

SIDELINE™

SIDELINE™ Filter Housings

Mid-priced filter housings for most applications.

- A SIDELINE housing is a solid, investment-cast filter in the medium cost range.
- A SIDELINE housing offers a standard eye-bolt closure and a choice of 2" or 3" ANSI flanged connections as standard.
- For filter bags sizes 01, 02, 03 and 04.
- Type 304 or 316 stainless steel construction means superior corrosion resistance and consistent performance, year after year. A smooth, bead-blasted finish, coupled with SIDELINE's minimum 2-weld design, makes it easy to completely clean the interior of the housing.
- All SIDELINE housings come with an exclusive Five Year Warranty and the ASME code UM stamp.
- SIDELINE housings... for all heavy duty industrial applications.

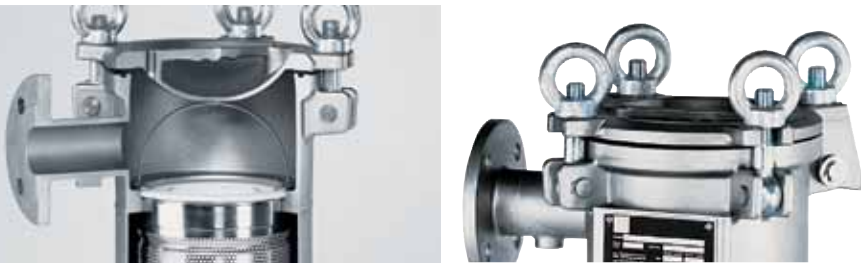

These value added features:

Side inlet with evacuation cover

Cover opening direction can be changed in the field

Compression bag hold down

Integral cover handle

Give these benefits

Less messy bag changing, no spillage of unfiltered liquid.

Easily adapts to different piping layouts. Accommodates walls, posts or other obstructions.

360 degree sealing of the filter bag to the housing.

Ergonomical and easy to open

See page 5 for dimensions.

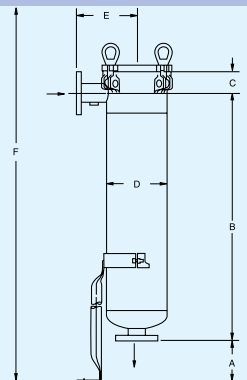

DUOLINE™ / MODULINE™ / TOPLINE™

DUOLINE™ Filter Housings

Duplex units for continuous filtration processes.

The DUOLINE bag filter system consists of two bag filter housings (SIDELINE housing or TOPLINE housing) fitted together at the inlet and outlet by either a butterfly or ball valve assembly. Valve assemblies are connected together by a center post handle assembly in order to guarantee a synchronised change from filter A to filter B. A quick turn of the handle diverts the flow from one filter housing to the other. The filtration process runs continuously during bag change-outs.

See page 5 for dimensions.

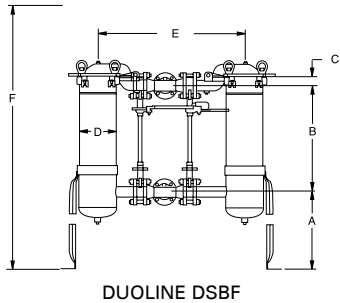

MODULINE™ Filter Housings

Double or modular multibag unit for larger flow rates.

The MODULINE filter housings are multibag units assembled from two or more standard SIDELINE (MSBF) or TOPLINE (MTBF) housings using standard ellbows, manifolds or T-Pipe modules. The MODULINE filter concept offers greater flexibility, capacity can be easily increased by adding further modules. MODULINE housings are fabricated to customer specifications.

See page 5 for dimensions.

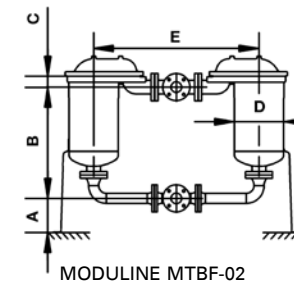
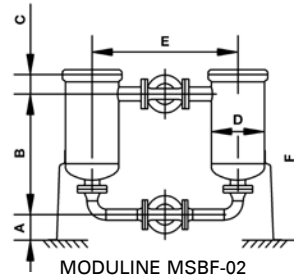

TOPLINE™ Dual Filter Housings

Compact 2-bag unit with single cover-lid.

The TOPLINE TBF-02 filter housing combines the advantages of the TOPLINE housing series with a compact 2-bag design. Features a single cover-lid, eye-bolt closure and standard adjustable leg assembly.

See page 5 for dimensions.

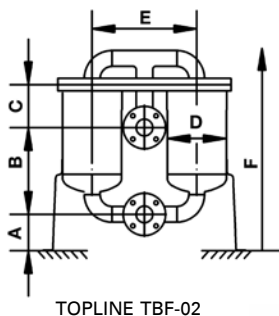

POLYLINE™

POLYLINE™ Filter Housings

Rugged, all plastic housings with a choice of PVC, CPVC, PPL or PVDF construction to meet the needs of all ultra-pure or corrosive applications.

- POLYLINE filter housings have no metal components to rust, corrode or contaminate the process media. Housings are available for size 01 or 02 filter bags (PVDF 02 only).
- With a POLYLINE housing you get extra features at no extra cost such as a vent/bleed valve installed on the housing cover and an integral mounting flange for rock solid installation without the need for support legs. The two bottom pipe connections are interchangeable as outlet or drain, allowing easy modification to in-line or loop piping arrangements to accommodate any installation design.
- The hand removable, no tools required, spin off cover makes filter bag changing quick and easy. Just a few turns of the cover using the built-in handle opens and closes the housing with little effort.
- For applications that require continuous flow, duplex models are available. Here, the flow never has to be shut down for bag change-out. For contamination sensitive or severely corrosive filtration applications, a POLYLINE housing is your best choice.



PPL/PVDF models feature external cover threads



PVC/CPVC models feature true union connections



Duplex models for continuous flow applications

Operating Temperature/Pressure for POLYLINE Filter Housings

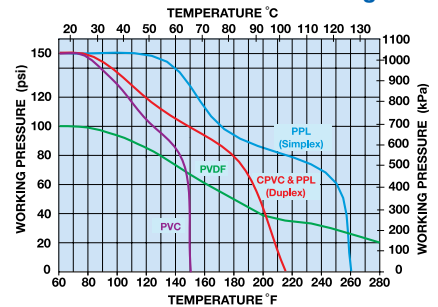

These value added features:

All plastic construction with smooth interior surfaces.

Hand removable spin off cover.

Two outlets

Duplex model available

Give these benefits

Easy to clean. Will never rust, corrode or contaminate the process media.

Fast bag change out, no tools needed to remove cover

Allows either in-line or loop piping connections with other outlet used as a drain.

Used in applications requiring continuous flow.

PVC/CPVC

PPL/PVDF

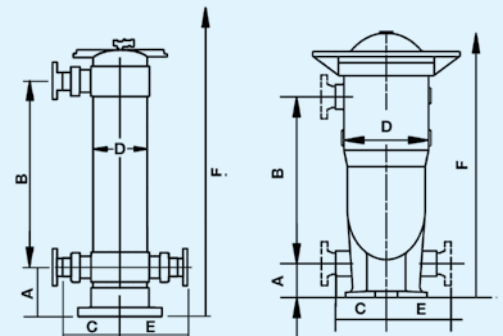

See page 5 for dimensions.

FLOWLINE™

FLOWLINE™ Filter Housings

Versatile, heavy-duty cost-effective filter housings.



- A FLOWLINE housing is the best choice for industrial, commercial and OEM applications that do not require a code stamp. The standard design is available with threaded or flanged connections.
- A cost-effective design incorporates all of the features heavy duty applications demand but in a lightweight construction.
- FLOWLINE housings feature a special design that uses a minimum number of welds for a smooth, easy to clean interior surface.
- For filter bags sizes 01 and 02.
- Available in carbon steel and Type 304 or 316 stainless steel for high corrosion resistance. A smooth, bead-blasted finish makes it easy to completely clean the interior of the housing.



These value added features:

- Fabricated construction
- Cover opening direction can be changed in the field
- Adjustable mounting legs
- Integral cover handle

Give these benefits

- Cost effective, lighter weight than a cast housing.
- Easily adapts to different piping layouts. Accommodates walls, posts or other obstructions
- Easier installation
- Makes it easier to open and close cover.

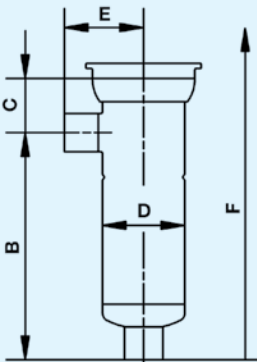

See Page 5 for dimensions.

ECOLINE™ Filter Housings

Lightweight, economical filter housings.

- ECOLINE housings have a lightweight design for commercial, OEM, non-hazardous, low pressure applications that do not require a Code Stamp.
- The cost-effective design incorporates a handy V-clamp closure and threaded couplings. The lid is fitted with a 1/4" NPT connection for easy fitting of a vent or gauge.
- For filter bags sizes 01, 02, 03 and 04.
- Type 304 stainless steel construction offers superior corrosion resistance and consistent performance. A smooth, bead-blasted finish makes it easy to completely clean the interior of the housing.



These value added features:

Cost effective design

Compression bag hold down

V-clamp cover closure

Side inlet with evacuation cover

Give these benefits

Perfect for cost sensitive applications.

360 degree sealing of the filter bag to the housing.

Easy to operate for quick cover removal and closure.

Less messy bag changing, no spillage of unfiltered liquid.

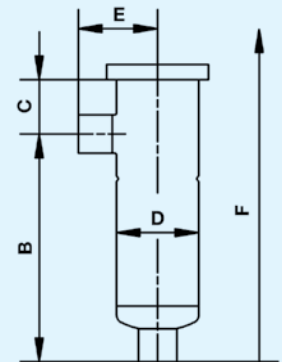

See page 5 for dimensions.

Lid gasket

Bag

ACCESSORIES

EATON FILTER HOUSING ACCESSORIES

Original Eaton Accessories, Consumables and Spare Parts for Safety and Reliability

The wide range of Eaton Filter Housing Accessories makes it possible to custom design a housing to the exact requirements of your application, no matter how complex or unique it may be.

Accessories can be used to improve processes as well as the application requirement itself. For example, displacement balloons make bag change-out easier, LOFNETIC magnetic inserts extend filter bag life in applications where magnetic particles are encountered.

Original Eaton "Added Value" Accessories are guaranteed to work with your Eaton filter housings as part of the system to deliver the highest performance and reliability.

01 Restrainer Baskets

Heavy duty, electropolished SS 316 perforated plate baskets (included with housing) allows use of filter bags and HAYFLOW™ elements up to differential pressures of 30 psi. Available in all standard sizes, fitting all Eaton bag filter housings. Specially designed restrainer baskets, including special of construction such as HASTELLOY or EPOXY coated, are available. Standard baskets can be used in combination with adaptor rings for retrofitting other types of housings.

02 LOFNETIC Magnets

Magnet assemblies are inserted into the filter bag during filtration. They are a combination of bag positioner fitted in the center with a magnetic bar(s). Lifetime is extended by retaining magnetic particles such as chips and fines, preventing deposition onto the filter media. They also retain finer magnetic dust when using bags of coarser micron rating. Eaton magnetic strainers are available in size 01 and 02 using one or two SS 316 covered magnetic bars.



03 Bag Positioner

Highly recommended for all installations, mandatory for some, bag positioners or "bag lock's" ensure correct positioning of the filter bag within the basket and eliminate any "bobbing" up and down movement of the bag caused by uncontrolled back pressure. This avoids any chance of bag bursting. ACCUGAF™, PROGAF™ and LOFCLEAR™ 500 filter bags need to be equipped with a bag positioner. A special new collar design firmly fixes the element inside the bag during filtration. They are available in sizes 01 and 02.



04 Leg Assembly

Height-adjustable leg assemblies are standard for size 01 and 02 TOPLINE™, FLOWLINE™, and SIDELINE™ housings, and optional for ECOLINE™ housings. Wall mounting brackets are also available.

05 Displacement Balloons

Inserting a displacement balloon inside the filter bag minimizes the amount of residual liquid present in the filter bag and reduces product loss. This eases the changing of the filter bags eliminating the need for

expensive pressure-aided draining systems. A special new collar design firmly positions the balloon inside the bag. The SS 316 balloons' maximum DP is 230 psi. They are available in sizes 01 and 02.

06 Manifold Modules

Eaton standard pipe modules are available in SS 316. 90° elbows, flange reductions, flanged "T" sections, and flange manifolds can be easily assembled to make DUOLINE™ or MODULINE™ bag filter versions based on FLOWLINE™, SIDELINE™ or TOPLINE™ size 01 or 02 housings.

07 Adapter Head for Open Filtration

Used in conjunction with SNAP-RING® filter bags in gravity feed open systems. Adapter heads are available in SS 316 and polypropylene with a 1.5" NPT connection for pressures to 20 psi.

08 Gaskets and O-ring Seals

As standard, Eaton metal filter housings are fitted with Buna N O-rings. Plastic housings have Viton® O-rings. Other material options such as EPDM, Viton, TFE encapsulated Viton or Silicone rubber are available as flat gaskets. The options offer a variety of chemical and thermal resistances to meet a multitude of uses and applications.

09 Mesh Strainers

Bag filter housings may be fitted with SS 316 mesh lined strainers in place of baskets to convert them to strainer filters. Mesh strainers are available in four standard sizes: 01, 02, 03 and 04, micron ratings are 25, 50, 100, 150, 250, 400, 800 µm respectively.

10 Miscellaneous

Gauges, Vents, Eye-bolts, Clamp-screws, V-clamps, Center-bolts, Butterfly and Ball Valves are available as accessories or spare parts to fit the various Eaton bag filter housings.

11 Bag Hold-down Rings

The various ECOLINE™, SIDELINE™, FLOWLINE™, POLYLINE™ and MAXILINE™ MBF bag filter housings are fitted with different bag hold-down rings (included with housing). They hold the filter bag securely inside the restrainer basket which in turn is positioned correctly within the housing.

FILTER BAGS

Eaton
Precision in
Filtration.
A Whole New
Way to Think
About Bag
Filtration
Systems



INTRODUCTION



Setting New Technology Boundaries

Demanding or critical liquid filtration applications require high performance filtration media. This media may have to be more efficient, stronger, longer lasting or conform to specific standards. Sometimes, a unique combination of these qualities can be required.

Eaton filter bags meet these stringent media requirements. The convenience and economy of liquid bag filtration is now feasible for filtration applications that previously required other, more expensive systems.

Change the way you've been thinking about filter bags... and explore the range of filter bags described in this catalog. You may find solutions to your most difficult filtration challenges here. Today's bags are capable of performing in applications that, in the past, required more complex and expensive filtration systems.



After you have finished reading about these special filter bags, contact us. Because demanding or critical applications can be complex, an Eaton Applications Specialist is available to perform a no-obligation analysis of your process. Learn how one of these high performance filter bags can work in your system, whether your system already exists or is in the design stage, and the improvements you can expect...before you make any commitment.

**PROGAF™, ACCUGAF™, LOFCLEAR™, DURAGAF™, HAYFLOW™
CLEARGAF™, SENTINEL®, SNAP-RING® and BANDSEAL™**

FILTER BAG FEATURES

What Makes an Eaton Filter Bag Better?

State-of-the-art media...advance construction...quality control...customer service...application specialists... in short, the entire Eaton organization teams up to bring you the most advanced bag filtration solutions available. Eaton has applications specialists available around the world to help first-hand with difficult, demanding applications. On-site trials demonstrate the best filter bag for any new application. Expert system software makes system sizing and optimization simple and effective. In short, commitment to our customers packs value-added quality into every product we sell.

Advanced Filter Design

Starting with unique element design and ending with sealing technology, Eaton products deliver performance in simple or complex applications. Multi-layer constructions, pleated extended surfaces, fully-welded constructions and pressure-activated seals are only some of the features which make Eaton filter bags the most advanced in the world. This range of design and construction offers filtration solutions over the full spectrum of fine filtration applications.

Advanced Filtration Media

No other range of filtration products can bring the wide range of filtration media and construction to either simple or demanding applications. Progressive structure media deliver efficiency and media life not available in any other technology. High-purity media styles permit filtration without contamination of the fluid. Heat-stabilized monofilament meshes deliver absolute filtration ratings in almost any fluid. High-quality felts deliver the most cost-effective filtration available today for straightforward applications. In short, full-spectrum performance.

Proprietary Fabrication Technology

Whether sewn or welded, simple or complex, Eaton filter bags are fabricated using the most advanced techniques and equipment in the world. Highly automated welding systems produce consistent, dependable bag construction. Eaton's proprietary UNIWELD system produces bag seals which are, at the same time, strong and flexible to conform to restrainer baskets. Food-grade products are fabricated in facilities where both the environment and materials are controlled to assure cleanliness. Repeatable, robust, cost-effective...technology working for our customers.

Rigorous Quality Standards

Every Eaton filter bag carries its own promise of quality to our customers. The QC tag permits full traceability of both materials and processes throughout fabrication and into service. Eaton ISO 9001:2000 facilities produce filter bags and vessels to standards demanded by demanding industries. From the simplest sewn filter bag to the most complex multi-layer construction, the quality is the same. No compromise...the Eaton promise to its customers.



NOMINAL ABSOLUTE

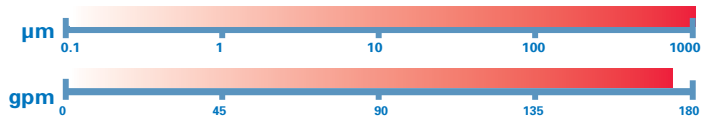

In this brochure, an application key appears for each bag style. You can use this key to select a bag based on particle size range and flow rate, for size O2 bags made of standard filter bag material.

COMPASS™ Expert System Software

Select a filter...size and optimize a system...search for your application. COMPASS brings over 30 years of application success to the fingertips of each Eaton Filtration Specialist. This breadth of experience is available in a customer's facility or over the phone, to provide rapid accurate estimates of system performance.

Worldwide Customer Support

Eaton has manufacturing facilities and customer support personnel located in North America, South America, Europe, Asia, Africa and Australia. There are 26 Eaton Regional Sales Offices and an independent, professional distribution network to serve the needs of our customers in 45 countries. Throughout the purchase, installation, and start-up of your Eaton Filtration System, an Eaton representative is always available to insure its performance.

THE CONTAMINANT SPECTRUM OF BAG DESIGN

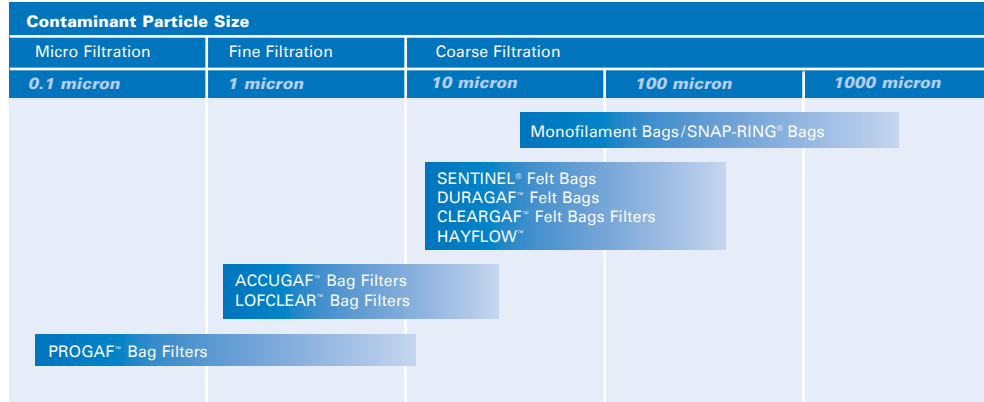

THE CONTAMINANT SPECTRUM OF MEDIA

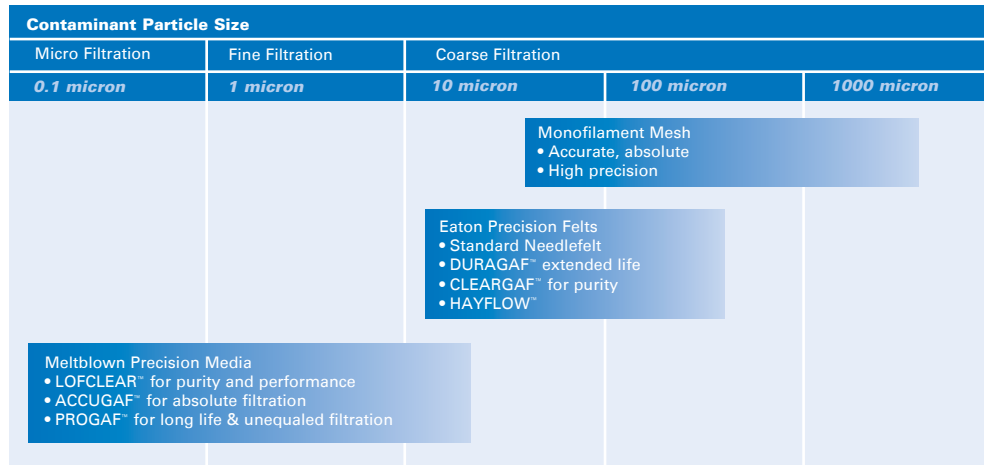

THE CONTAMINANT SPECTRUM OF FILTER SEALS

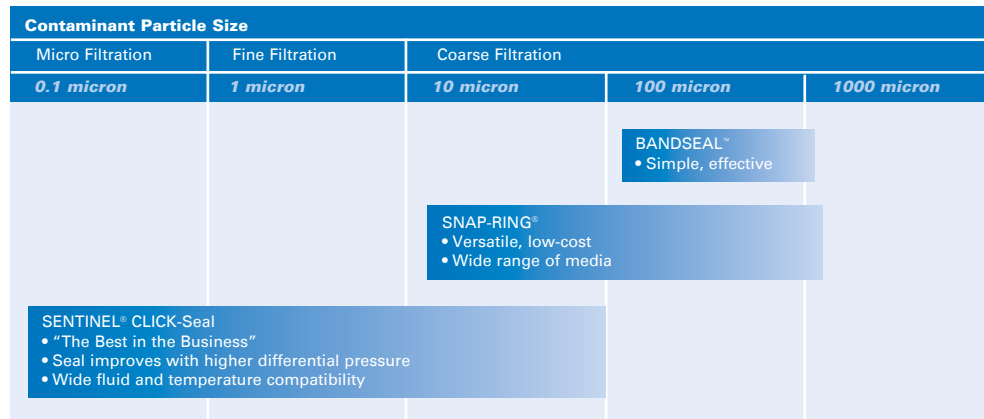

PROGAF™

The Filter Bag that Works Better Than a Filter Cartridge



The SENTINEL plastic step-ring seal provides a seal between the filter vessel and the PROGAF Filter Bag. As the pressure differential rises inside the vessel, the seal becomes more efficient.

PROGAF filter bags bring a new, high-performance alternative to applications requiring absolute filtration. PROGAF filter bags' progressive density depth filtration delivers high efficiency (up to 99.98%) and long life with all the convenient features of a bag filter. In comparison with other filtration technologies, PROGAF filter bags deliver lower operating costs while retaining the ease of change-out typical of a bag filter.

Welded Construction for Superior Performance

All PROGAF High Performance Filter Bags feature 100% welded construction for better filtration performance. This construction ensures that nothing bypasses the process media through holes in the fabric created from sewing the material. Eaton's proprietary welding technology produces a super-strong seam that stands up to the most demanding applications.

PROGAF™ Filter Bags Seal Better in Critical Applications

The SENTINEL® ring provides a flexible, chemically-resistant seal which adapts to any filter vessel. This unique design employs a pressure-activated sealing lip which responds to increases in differential pressure. As the pressure increases, the seal of the ring improves, guaranteeing bypass-free performance over all ranges of pressure, temperature and micron rating. The elevated bag handles make removal quick and easy.

Unique Progressive Density Media Structure

PROGAF filter bags utilize an advanced media structure developed specifically to deliver both long life and absolute filtration. PROGAF filter bags' progressive density design uses up to 12 layers of media which become finer and finer as fluid passes through. The result is a gradual removal of con-



PROGAF™ Filtration Ratings

Filter Model	Particle Size at Common Removal Efficiencies (µm)					ΔP (psi) Size 02 @ 45 gpm
	>60%	>90%	>95%	>99%	>99.9%	
PGF 50	-	-	.15	.45	1	3.6
PGF 51	>80@0.15	.3	.45	.5	2	2.5
PGF 55	1	3	6	10	12	0.9

Filtration efficiency confirmed by independent test laboratory

ABSOLUTE

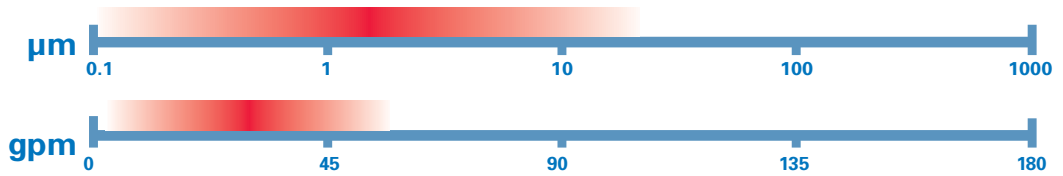

taminant without any single layer blinding prematurely. Application and laboratory tests confirm that PROGAF bag filters deliver longer service life and lower operating costs than any other renewable filter element. The 100% polypropylene construction provides pure, silicone-free materials in an economic, self-contained, easily disposable filter bag.

Filtration Efficiencies of Up to 99.9%

PROGAF High Performance Filter Bags have performance efficiencies of up to 99.9%...true absolute filtration. In many filtration applications of one micron and above, PROGAF Filter Bags can replace expensive cartridge filtration systems and provide better performance while saving time and money. Ask your Eaton Filtration Specialist for "real world" documented case histories, illustrating how PROGAF Filter Bags have performed in applications similar to yours.

The PROGAF™ Filter Bag Difference

Ordinary standard filter bags are made from needled felt media that has a fiber structure not as fine and precise as the filtration grade melt blown media used for PROGAF Filter Bags. The needled fibers are much larger in size and spaced much further apart, yielding a lower efficiency. PROGAF Filter Bags have been designed to deliver calibrated fractional efficiency on very small particles, down to less than one micron.

The bags feature a completely welded construction and the unique, SENTINEL® Sealing Ring for a positive by-pass free seal. And all PROGAF Filter Bags have a round bottom shape for increased pressure stability.



Unique layered construction structure

Choose Just the Filtration Efficiency Your Application Needs

PROGAF Filter Bags are available in efficiency codes of 50, 51, and 55. To select the perfect PROGAF Filter Bag for your application, choose the micron retention efficiency level you need on the left side of the chart at particle size in microns at the bottom. Next, locate the bag efficiency code (identified by the colored lines) that is closest to that point. There you have it: the most cost effective filter bag for your critical filtration application.

Fractional Efficiency of PROGAF™ Filter Bags
(ISO Fine in water at ambient conditions @ 90 gpm)

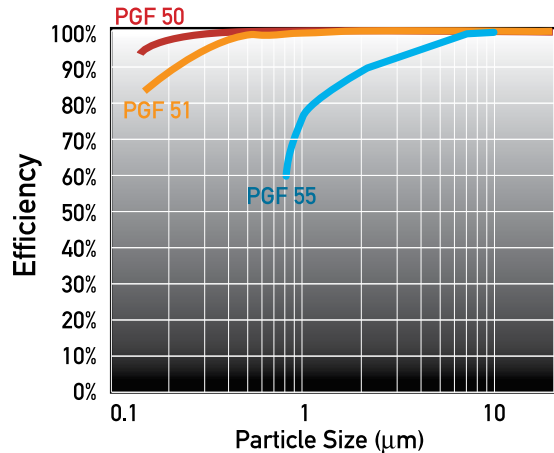

Clean ΔP of PROGAF™ Filter Bags
(Water at ambient conditions)

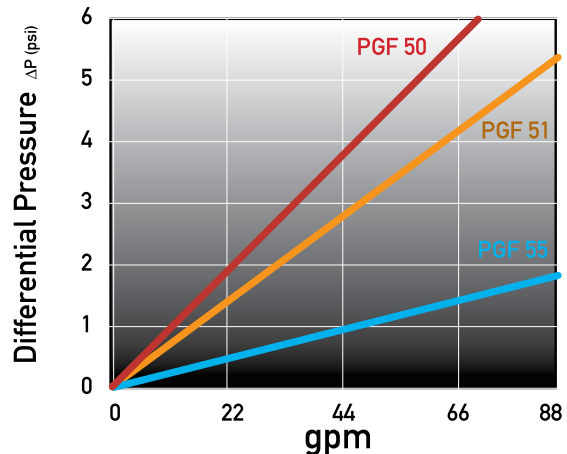

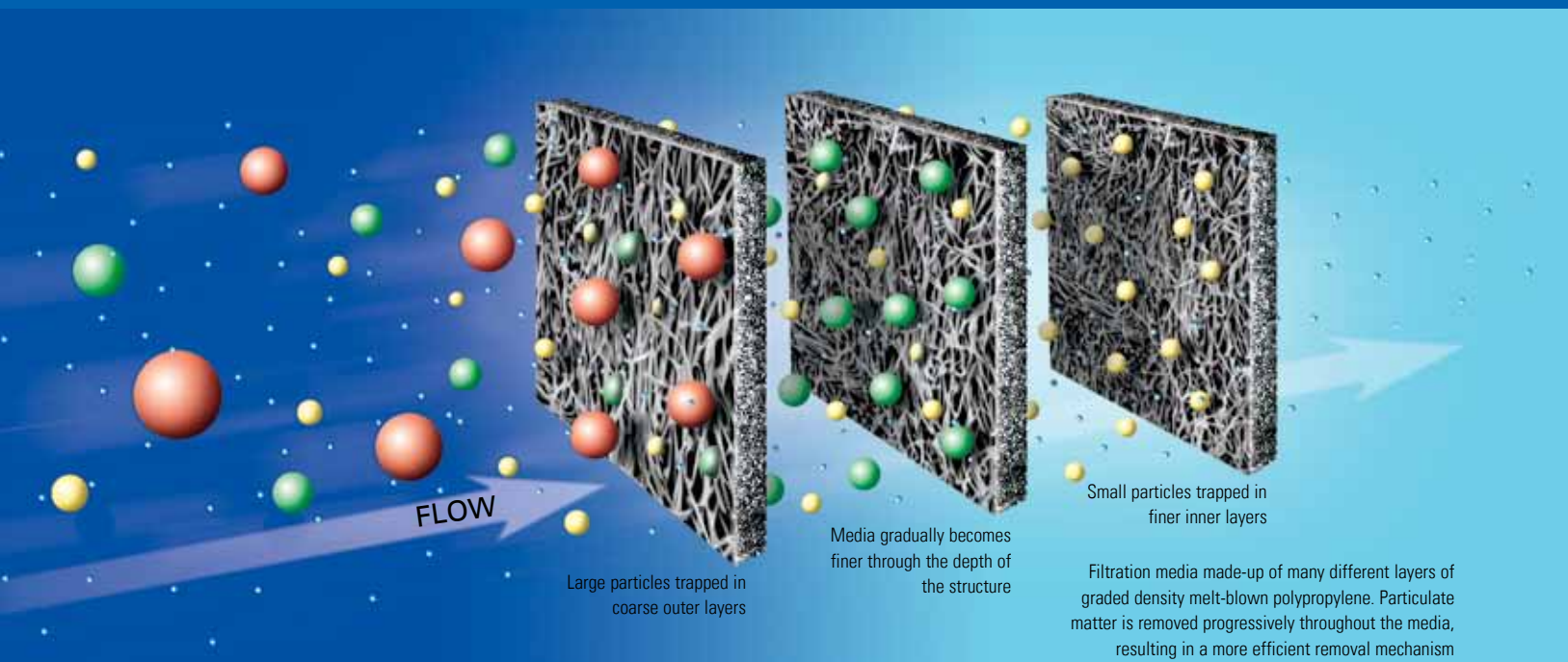

Some Typical Applications

All materials used in the construction of PROGAF Filter Bags, including the multilayer melt-blown polypropylene media, are FDA/EC listed materials that meet their requirements for food contact applications. But food or beverages are not the only applications that can take advantage of PROGAF filter bags' high filtration efficiencies and capacity retention. The pharmaceutical, micro-electronics, chemical, food, ink and paint, and water treatment industries can also use PROGAF High Performance Filter Bags.

Chemical and Pharmaceutical Industries

Demanding filtration in high-purity industries are the applications PROGAF filter bags were made for. Media capable of removal to 2 μm absolute with long service life is essential for activated carbon removal or catalyst recovery. Gel removal requires a deep matrix of fine fibers. A PROGAF bag is ideally suited for each of these applications. Available in four filtration ratings, one of the PROGAF bags will deliver just the needed performance.

Water Filtration

Water filtration applications have traditionally been dominated by cartridge filtration. Following extensive worldwide trials, PROGAF 51 has demonstrated a log 3.5 reduction of impurities in these demanding applications.

Micro-Electronics

These applications typically require chemicals that are constantly filtered to extremely low levels of particle contaminant. PROGAF filter bags' special profile, with its high efficiency media and graded density structure, provides performance characteristics superior to that of traditional cartridge type filtration. PROGAF filter bags outperforms cartridges in terms of dirt-holding capacity, service life, and cost. Membrane prefiltration significantly reduces the SDI values in water filtration.

Compare PROGAF™ to Filter Cartridges and See the Difference

The two charts on the next page graphically illustrate the advantages of PROGAF High Performance Filter Bags over different types of filter cartridges. PROGAF Filter Bags and filter cartridges come in many shapes and sizes. Compare PROGAF Filter Bags with their cartridge equivalent in material, micron rating and industry qualifications. Progressive structure of PROGAF filter bags delivers operating differential pressure which starts and remains lower during filter life than other comparable filters. The chart shown here illustrates the results of actual comparison tests made against two common styles of cartridge filters: depth-loading and pleated polypropylene. During laboratory loading tests, the PROGAF filters remained at the lowest differential pressure of any of the three over the life, illustrating the effectiveness of the progressively structured media.

OPERATIONAL CONSIDERATIONS

Bag Positioner

To ensure proper performance, PROGAF Filter Bags must be used with the Eaton Bag Positioner. Using them together aids bag insertion into the filter housing and assures correct alignment of the bag inside the restrainer basket, preventing the bag from being pushed out of the restrainer basket in case of reverse flow, and makes bag removal easier.

Pre-Wetting in Aqueous Solutions

PROGAF filter bags are fabricated from fine polypropylene filtration media. This material is hydrophobic, which means that water will not wet the surface of the fibers. Therefore, a fluid with lower surface tension must first be used to wet the fibers, as well as cartridge filters made from this material. Prior to installation, you must first immerse the bags for a few minutes in a wetting solution compatible with the process fluid. After the fibers are wet, water is drawn in by capillary action. Full details about how to install and pre-wet PROGAF Filter Bags are provided in the installation instructions.

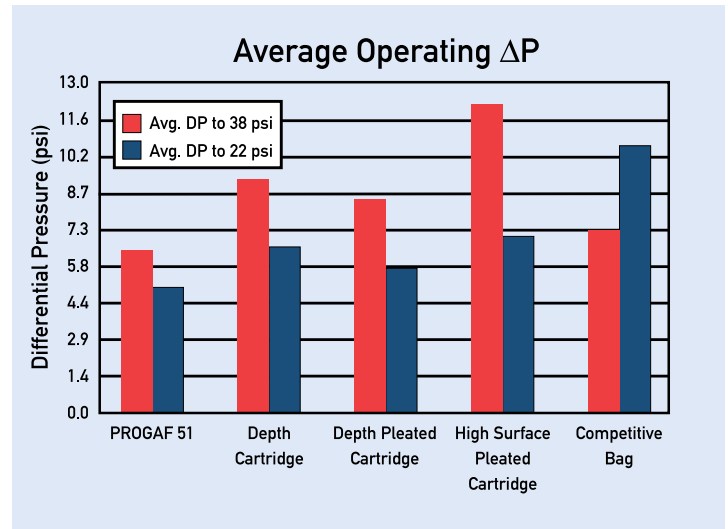
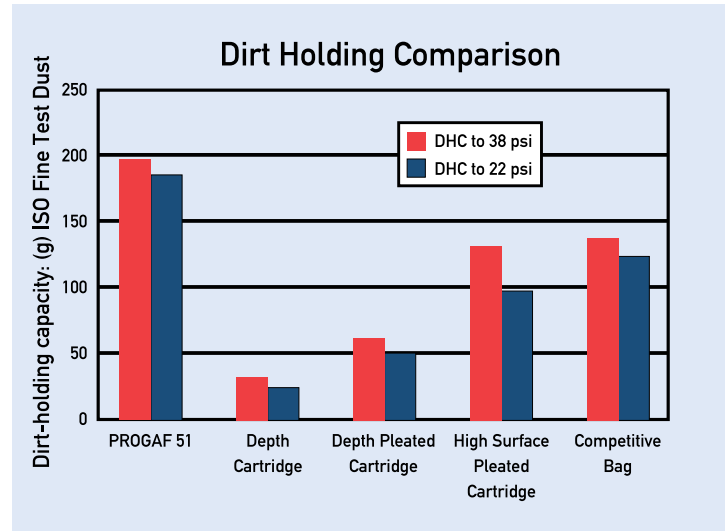

PRODUCT CODES

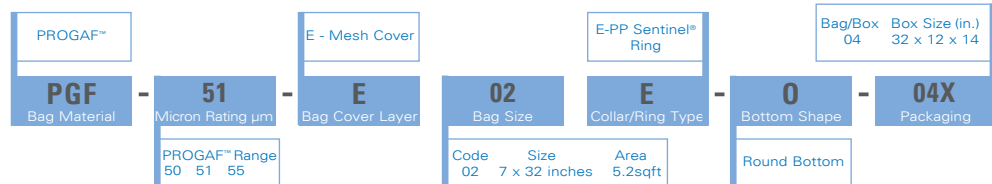

ACCUGAF™

ACCUGAF™, Filter Bags for Applications Demanding Efficiency >99%

The ACCUGAF filter bag pushes the boundaries of bag filtration technology far beyond traditional designs. With efficiencies >99%, each ACCUGAF model provides cost-effective filtration solutions for demanding applications. The five models assure users that particles from the range of 1.25 microns can be removed effectively while delivering long service life.

High-Efficiency Performance

ACCUGAF filter bags feature:

- 100% welded seams
- SENTINEL® seal ring
- Meltblown filtration media in polypropylene or polyester
- No additives, such as resins, binders or surface treatments

FDA Compliant Materials

ACCUGAF Polypropylene filter bags are constructed entirely of materials compliant to FDA requirements for materials in contact with food. All materials conform to US Code of Federal Regulations 21 CFR Part 177 and EU Directive 2002/72/EC.

Applications

Although ideally suited for food and beverages, ACCUGAF filter bags will deliver equal performance in a wide range of demanding applications such as:

- Beer, wine, spirits and beverage filtration
- Fine particle removal in parts cleaning
- Final filtration of lacquers
- Final filtration of vinegar
- Activated carbon removal in process systems
- Final filtration of hydraulic oils and lubricants

ACCUGAF Filter Bag Filtration Ratings

Material	Filter Model	Particle Size at Common Removal Efficiencies (µm)					ΔP (psi) Size 02 @ 45 gpm	Max Op. Temp (°F)
		>60%	>90%	>95%	>99%	>99.9%		
Polypropylene	AGF 51	0.2	0.6	0.8	1.5	5	1.30	190
	AGF 53	0.8	1	2	3	5	3.20	190
	AGF 55	1	2	3	5	15	0.73	190
	AGF 57	2	4	5	10	25	0.60	190
	AGF 59	10	25	30	25	35	0.44	190
Polyester	AGFE 51	0.2	0.6	0.8	1.5	5	1.30	320
	AGFE 55	1	2	3	5	15	0.73	300
	AGFE 57	2	4	5	10	25	0.60	300

Filtration efficiency confirmed by independent testing laboratory.

ABSOLUTE

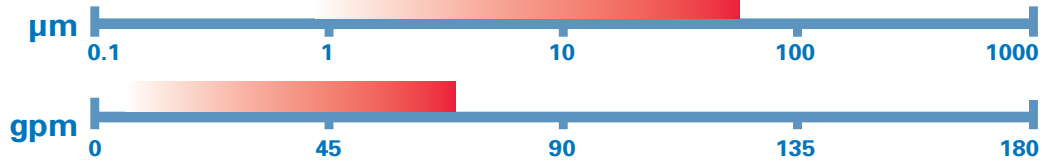

OPERATIONAL CONSIDERATIONS

Bag Positioner

ACCUGAF filter bags must be used with the Eaton bag positioner. This eases insertion and assures correct alignment of the filter bag inside the restrainer basket. In addition, the filter bag will be protected against damage to inadvertent back-flow.

Pre-Wetting in Aqueous Solutions

ACCUGAF polypropylene filter bags are fabricated from microfiber filtration media. These materials are hydrophobic, indicating that water will not wet the fiber surfaces. As will all other fine polypropylene filters, a lower surface tension fluid (wetting agent) must be used to wet the media prior to introducing water. Prior to service, the filter bags must be immersed in a wetting solution compatible with the process fluid. After wetting, an aqueous fluid will be drawn into the media through capillary action. Full details about installation and wetting are provided with every box of ACCUGAF filter bags.

AGFE Polyester

For use in higher temperature applications and there is no need for pre-wetting in aqueous solutions.

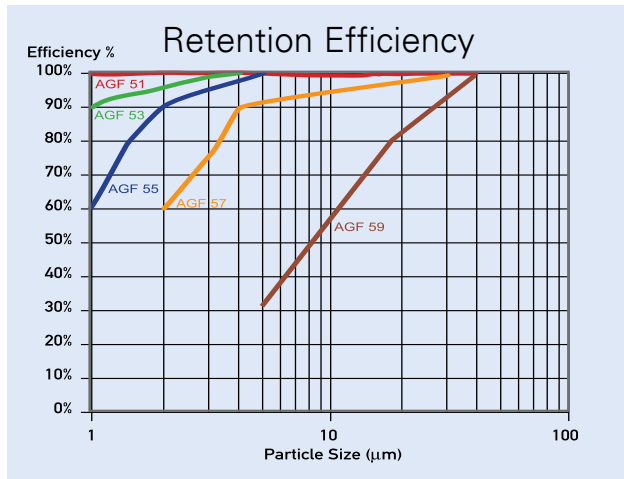

ACCUGAF Filter Bags are available in retention codes of 51, 53, 55, 57, and 59. To select the perfect ACCUGAF Filter Bag for your application use the chart and choose the retention efficiency level you need on the left side of the chart at particle size in microns at the bottom. Next find which bag efficiency code (identified by the colored lines) is closest to that point. There you have it, the most cost effective filter bag for your critical filtration application.

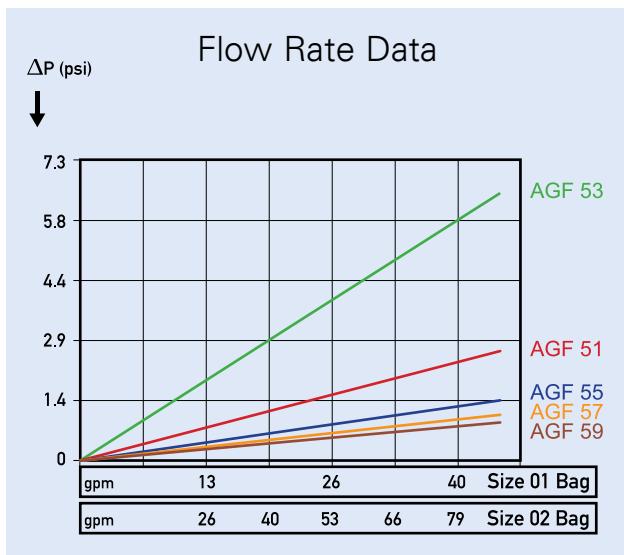

PRODUCT CODES

ACCUGAF™ AGF: polypropylene melt-blown AGFE: polyester melt-blown	E: Polypropylene Mesh R: Polyester Mesh	E: PP SENTINEL® Ring H: Hytrei SENTINEL® Ring	Bags/Box/Box Size (inches) 01/02 10M 19 x 12 x 14
AGF Bag Material	53 Micron Rating µm	E Bag Cover Layer	O Bottom Shape
AGF 51 AGF 53 AGF 55 AGF 57 AGF 59	AGFE 51 - AGFE 55 AGFE 57 -	02 Bag Size	10M Packaging
		E: Collar/Ring Type	round bottom
		Code Size Area 01 ø 7 x 17 inches L 2.6 sqft 02 ø 7 x 32 inches L 5.2 sqft	

LOFCLEAR™

Cost Effective Filter Bags for Absolute Filtration Applications

LOFCLEAR filter bags now make absolute filtration viable in many applications where only standard bags could be used due to cost constraints. Made from 100% pure polypropylene materials compliant with food requirements, LOFCLEAR filter bags contain no leachables or lubricants such as silicone oils. In addition, their excellent oil adsorbancy makes LOFCLEAR filter bags ideally suited to the oil removal needs of the paint and coatings industries.

Two Series to Match Filters to Applications

LOFCLEAR filter bags are available in two styles, Series 100 and Series 500. These two styles make it possible to match the requirements of a wide range of applications, depending on the needs for efficiency and long life. The Series 100 filters use a multi-layer construction for applications where high efficiency is of prime importance. The Series 500 filters utilize a patent pending pleated construction to increase surface area for applications requiring high dirt capacities and long life.

Perfect for Removal of Gelatinous Materials

LOFCLEAR filter bags have proven to be highly effective in the removal of gelatinous contaminants. The combination of deep microfiber filtration media

LOFCLEAR™ Filter Bag Filtration Ratings

Filter Model	Particle Size at Common Removal Efficiencies (µm)				ΔP (psi) Size O2 @ 45 gpm
	>60%	>90%	>95%	>99%	
113/123	0.5	1	2	4	0.36
114/124	0.75	2	3	5	0.30
115/125	1.5	3.5	8	10	0.15
116/126	2	6	13	15	<0.15
118/128	25	35	37	40	<0.15
119/129	15	25	27	30	<0.15
130	6	14	15	20	0.72
135	1	6	8	10	0.29
522	0.5	1	1.5	2.6	1.45
525	1	2	3.5	6	0.26
527	2	5	9	13	0.15
529	10	20	23	32	<0.15

Filtration efficiency confirmed by independent test laboratory.



breaks up gels and retains them within the media depth. These features prevent surface blockage and breakthrough typical of standard filter bag materials.

LOFCLEAR™ Series 100 Filter Bags

LOFCLEAR Series 100 Filter Bags feature a proven three-layer construction with a sewn filter welded to the SENTINEL® seal. They feature efficiencies >99% over a wide range of particle sizes, with dirt capacities up to 1/2 pound. The seven models feature:

- Polypropylene prefilter
- Meltblown polypropylene microfiber final filter
- Polypropylene outer migration barrier

LOFCLEAR Series 100 filter bags are an excellent choice for application such as high-purity fluids with low particulate concentration, first-pass guard filtration, oil adsorption and activated carbon removal.

The LOFCLEAR 128 and 129 were especially developed for the filtration of electro-coatings in the automotive industry. The filtration design allows pigments to pass through the filtration layers, while retaining impurities and removing silicones and other crater-forming substances. The LOFCLEAR 130 filter bag adds extra adsorption capacity for retaining high amounts of oils or other crater-forming substances. The LOFCLEAR 135 delivers high removal of particulate and oils for clearcoat applications where pigment removal is not an issue.

ABSOLUTE

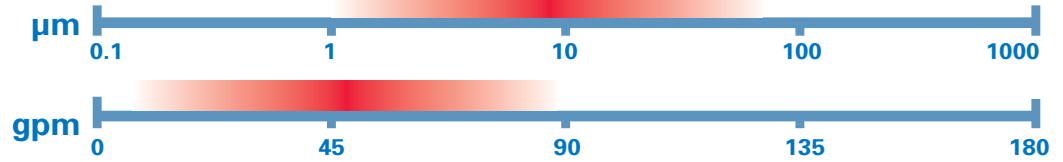

LOFCLEAR™ Series 500 Filter Bags

LOFCLEAR Series 500 Filter Bags have an all-welded multi-pleated construction for high efficiency and long life. This series of bags has a pleated prefiltration layer and a complex design of final filtration layers, allowing the removal of difficult-to-filter gels and deformable particles with a high capacity of solids loading. The outer web covering eliminates any downstream fiber migration.

LOFCLEAR Series 500 Filter Bags are available in four different efficiency ratings so you can choose your exact required filtration efficiency. LOFCLEAR Filter Bags have filtration efficiencies from 95 to 99%, with a dirt-holding capacity of over 2 pounds.



Among the many applications for LOFCLEAR Series 500 Filter Bags are oils, slurries, dilute oil removal, re-circulating batch systems, and systems with heavy contamination.

A pleated prefilter provides a very large surface (about 32 sq ft) to collect gels and solids before it reaches the final filter layers.

Operational Considerations

LOFCLEAR Series 500 Filter Bags must be used with an Eaton bag positioner. This eases insertion and

assures correct alignment of the filter bag inside the restrainer basket. In addition, the positioner protects the filter bag from potential damage that could be caused by inadvertent back-flow.

PRODUCT CODES 100 series

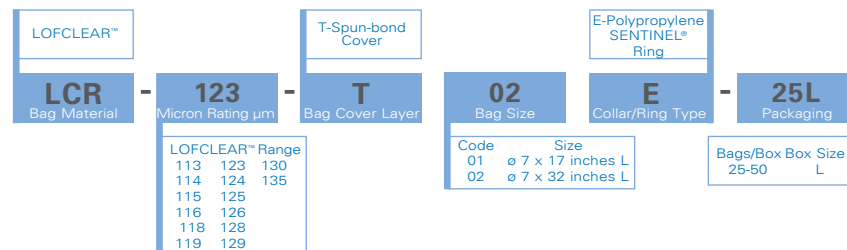

PRODUCT CODES 500 series

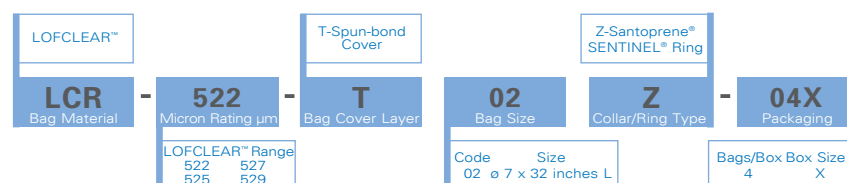

DURAGAF™

Extended Life Filter Bags Can Improve Your Filtration Process and Save You Money

DURAGAF™ Filter Bags for High Performance

DURAGAF filter bags represent the state-of-the-art in needled felt bag filter media. Their unique structure delivers equal filtration performance with lifetimes 2-5 times longer than ordinary felt media. The result is reduced operating costs due to lower bag consumption, downtime, change-out labor, storage and disposal.

Why DURAGAF™ Filter Bags Last Longer

DURAGAF filter bags are available in two extended life materials: polypropylene (code POXL) or polyester (code PEXL). These two materials utilize a fiber blend with a finer fiber diameter and a higher weight than ordinary media. The result is a dramatically higher dirt holding capacity at the same efficiency and differential pressure. Processes run longer and need fewer bag changes with DURAGAF filter bags.

All-Welded Construction for Superior Performance

All DURAGAF filter bags feature 100% welded fabrication and the Eaton SENTINEL® seal. This construction eliminates the bypass which can occur in standard sewn filter bags. Eaton proprietary welding technology produces a super-strong seam that will stand up to even the most demanding applications without failure.

DURAGAF™ Filter Bags Seal Better in Critical Applications

The SENTINEL® seal is standard on all DURAGAF filter bags. The unique, pressure-actuated ring actually improves its seal as differential pressure increases.

No Downstream Fiber Contamination

All DURAGAF filter bags are manufactured with a proprietary downstream surface treatment to prevent fiber migration. A special finish is obtained by glazing the surface, melting fibers together to form a tight, secure downstream matrix. In addition, the weld seams are heat bonded to eliminate loose fibers which might result during fabrication.

Food and Beverage Applications

DURAGAF filter bags are available in models (POXLF, PEXLF) which are compliant with FDA and EC requirements for food contact.



NOMINAL

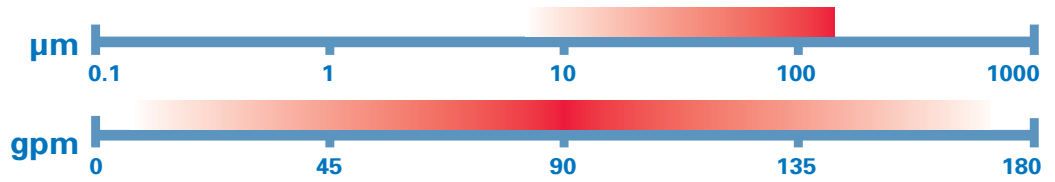

How much longer will a DURAGAF™ Filter Bag last in your application?

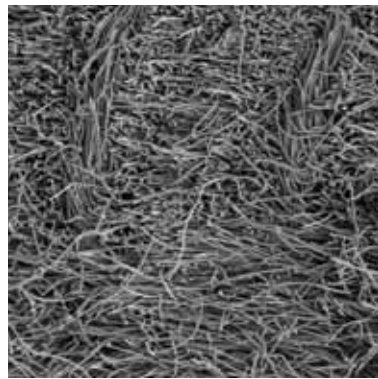
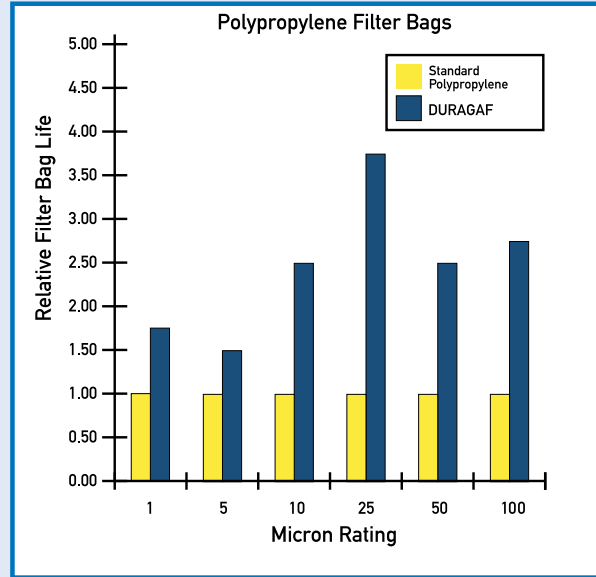
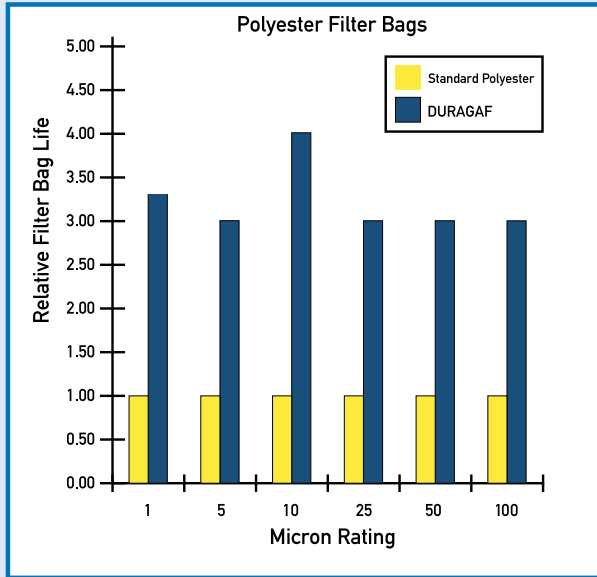

Extended Life Felt
finer fibers
more pores
thicker media

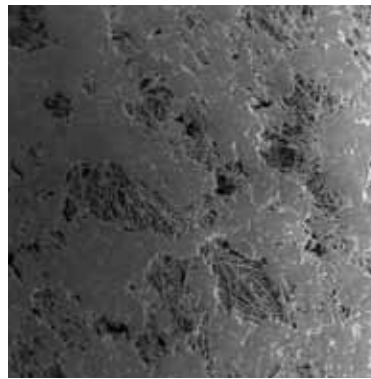

Surface of Extended Life Felt
no fiber release
full flow through surface channels

PRODUCT CODES

DURAGAF™ POXL: Polypropylene PEXL: Polyester POXLF: Polypropylene Food Grade PEXLF: Polyester Food Grade		P: Plain	E: Polypropylene SENTINEL Ring, Welded (POXL/POXLF) H: Hytrel SENTINEL Ring, Welded (PEXL) Z-WW: Santoprene SENTINEL Ring, Welded (PEXLF)																			
POXL	50	P	01	E	30L																	
Bag Material	Micron Rating µm	Bag Cover Layer	Bag Size	Collar/Ring Type	Packaging																	
<table border="1"> <thead> <tr> <th>POXL/PEXL</th> <th>PEXLF</th> <th>POXLF</th> </tr> </thead> <tbody> <tr> <td>1 5</td> <td>1 5</td> <td></td> </tr> <tr> <td>10 25</td> <td>5 10</td> <td></td> </tr> <tr> <td>50 100</td> <td>10</td> <td></td> </tr> </tbody> </table>		POXL/PEXL	PEXLF	POXLF	1 5	1 5		10 25	5 10		50 100	10		<table border="1"> <thead> <tr> <th>Code</th> <th>Size</th> </tr> </thead> <tbody> <tr> <td>01</td> <td>ø 7 × 17 inches</td> </tr> <tr> <td>02</td> <td>ø 7 × 32 inches</td> </tr> </tbody> </table>		Code	Size	01	ø 7 × 17 inches	02	ø 7 × 32 inches	Bags/Box Box Size (mm) L: Large
POXL/PEXL	PEXLF	POXLF																				
1 5	1 5																					
10 25	5 10																					
50 100	10																					
Code	Size																					
01	ø 7 × 17 inches																					
02	ø 7 × 32 inches																					

CLEARGAF™



CLEARGAF™ Filter Bags Fully Compliant and Approved for Food and Beverage Service

CLEARGAF™ Filter Bag Features Deliver Advanced Benefits

- Compliant materials assure compatibility with all food applications. Sewn bags use special lubricant-free thread
- Independent verification guarantees conformity to EC and FDA requirements
- Low-migration media minimizes substances introduced to fluids
- SENTINEL® Ring Bag Seals eliminate fluid bypass
- All-welded construction eliminates fluid bypass through needle holes on felt and multi-layer filter bags
- Controlled production eliminates contamination from handling and environmental conditions
- Single packaging keeps bags free from contamination during shipping, storage and installation
- Special handling & storage ensures that there is no contamination after packaging

CLEARGAF filter bags are the first and only series of filter bags specifically designed for the requirements of the food, beverage and pharmaceutical industries. Comprised of several filter styles, CLEARGAF is the only filter bag to deliver:

- Fully FDA compliant materials per 21 CFR 177
- Fully EC compliant per Directive 2002/72/EC
- Independent testing and certification
- Special single packaging and warehouse control

CLEARGAF™ Filter Bags for Direct Contact with Foodstuffs

Filter Bags are widely used for the filtration of fluids that are directly or indirectly used as foodstuffs. In most applications, these types of filters must be carefully selected to ensure that foodstuffs are not contaminated from their use. Most materials used to manufacture disposable filters, including bag filters and cartridge filters, are polymers, which are generally selected for their purity in the application. Many of these materials, however, contain materials that can diffuse out of the plastic into the process fluid. This effect, known as migration, can lead to foodstuff contamination. For this reason, the use of polymers is often limited to products such as CLEARGAF Filter Bags, which are made from materials that have been documented as safe in food applications. CLEARGAF Filter Bags conform to both US FDA and European EC

regulations. The difference between the FDA and EC regulations is one of degree. FDA regulation limits on migration are proportional to weight. EC limits, however, are based on area, and must be demonstrated in tests on finished articles. For heavy material, the EC limits can be up to 50 times more restrictive than the FDA ones.

Independent Verification

You can be sure all CLEARGAF Filter Bags meet these requirements, because they have been evaluated, tested and certified for EC migration performance by an independent food research institute. CLEARGAF Filter Bags are also made only from materials listed in the US Code of Federal Regulations Title 21 Part 177. No other materials are added during fabrication.

Special Manufacturing and Packaging

CLEARGAF Filter Bags are manufactured under special conditions to ensure that they contain no contamination. Immediately after manufacture, each bag is individually sealed in protective plastic packaging to keep them contamination-free. Eaton has special warehousing facilities for CLEARGAF Filter Bags to further protect them during storage. No other manufacturer goes to these lengths to ensure the quality of their food grade filter bags. For less demanding food and beverage applications, Eaton offers a line of cost effective filter bags that are appropriate for many applications.

ABSOLUTE/ NOMINAL

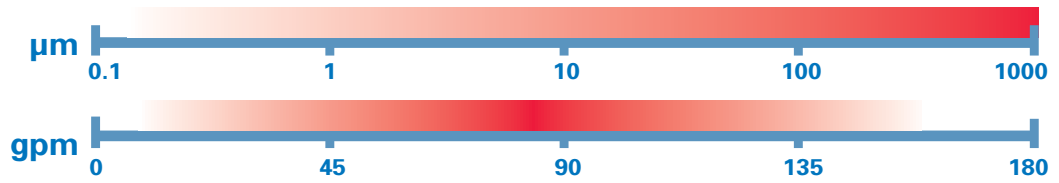

Selection Chart

	Max.Temp (°F)	Sizes				Available Grades											Ring Style			
		01	02	03	04	1	5	10	25	50	80	100	150	200	250	400		600	800	
PEF	285	█	█			█	█	█	█	█										Z
PEXLF	285	█	█			█	█	█	█	█										Z
POF*	195	█	█			█	█	█	█	█		█								E
POXLF*	195	█	█			█	█	█	█	█										E
NMOF	285	█	█	█	█															Z
AGF*	195	█	█																	E
PGF*	195	█	█																	E

*Products subject to MPQ in Europe applications. See Technical Bulletin TB990801 for full details.

PRODUCT CODES

- PEF: polyester needlefelt
- PEXLF: extended life polyester needlefelt
- POF: polypropylene needlefelt
- POXLF: extended life polypropylene needlefelt
- NMOF: nylon monofilament
- AGF: polypropylene meltblown
- PGF: polypropylene meltblown

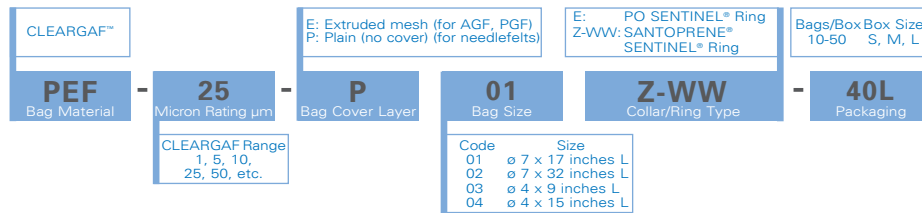

BANDSEAL™

NOMINAL

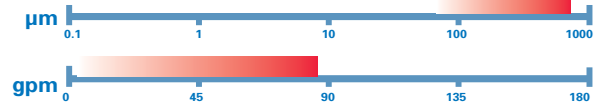

For simple, minimal-pressure non-critical open filtration applications (that is, filtration without a vessel), a BANDSEAL Filter Bag offers many cost-effective choices.



These filter bags are available with a drawstring that permits them to be installed directly on the end of a pipe, without the need of an adapter.

PRODUCT CODES

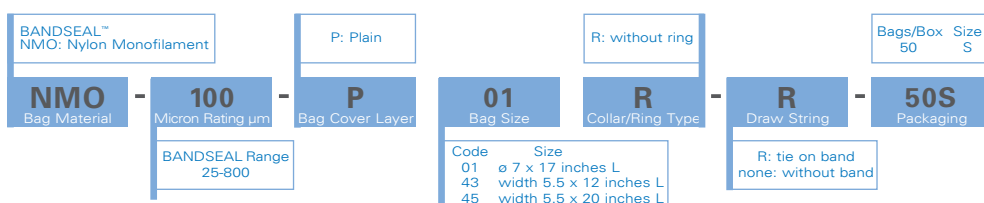

NOMINAL

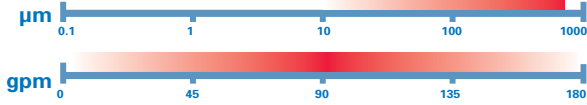

SENTINEL®

Welded Construction Filter Bags



Welded Construction Filter Bags

SENTINEL filter bags represent the industry standard in bypass-free filter construction. Available in polyester and polypropylene materials, all SENTINEL filter bags feature:

- SENTINEL Pressure Actuated Seal Ring
- Silicone Free Needled Felt
- Super Strong Welded Construction
- Non Migrating Media Construction

Proprietary Construction

Proprietary construction processes produce a reliable, durable filter bag. All seams are fully welded, producing strong, reliable joints with no by-pass or loose sewing thread. Seams are both strong and flexible, allowing the filter bag to form to the restrainer basket. The seam edges are heat sealed, eliminating possible loose fibers. This results in a filter bag with durable performance for the most demanding applications.

SENTINEL® Seal Ring

All SENTINEL filter bags utilize the SENTINEL seal. Its all-plastic construction provides a flexible, chemically resistant seal which adapts to any filter housing. This unique design employs a pressure activated sealing lip which responds to increases in differential pressure. As the pressure increases, the seal of the ring improves, insuring by-pass free performance over all ranges of pressure, temperature and micron rating. The elevated bag handles make removal of the bag from the vessel quick and easy. When a SENTINEL filter bag is installed into an Eaton filter vessel, the ring snaps into place, holding its position until the vessel is closed.

Now, applications requiring polypropylene or polyester felt filter bags can take advantage of the all-welded construction afforded by Eaton SENTINEL® Filter Bags. These bags, made from silicone-free materials, feature super-strong welded construction rather than sewn seams. This construction ensures that nothing bypasses the process media through holes in sewn fabric.

PRODUCT CODES

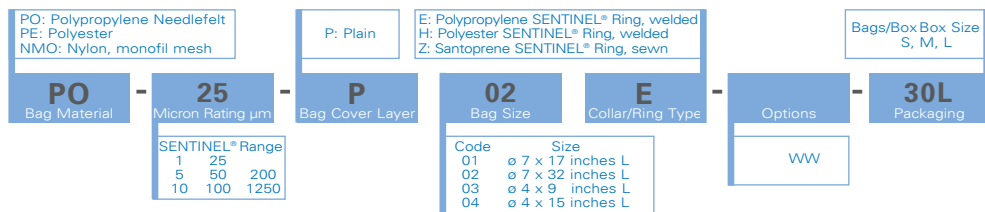

SNAP-RING®

NOMINAL

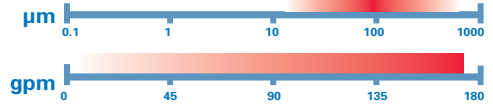

Sewn Construction Filter Bags

For over 30 years, SNAP-RING® filter bags have been critical components of filtration systems worldwide. The wide range of media materials, affordable price, and reliability of construction have made them the ideal choice for applications in nearly all process industries.

Superior, Consistent Quality

SNAP-RING filter bags are manufactured to the highest standards of fabrication available. Materials must satisfy stringent specifications for filtration performance and media purity. Production under 9001:2000 quality systems results in order to order, year to year, reliability and repeatability. Heavy duty sewing thread and the metal seal ring are produced to Eaton specifications and guaranteed to be silicone free.

Adaptable to Most Vessels

SNAP-RING filter bags are designed and constructed to fit the widest range of filter vessels, whether from Eaton or from another supplier. Special geometries are available to fit most non-standard housings.



Cutaway showing SNAP-RING sewn into the bag

PRODUCT CODES

Multifilament Mesh
PEMU: Polyester

Monofilament Mesh
NMO: Nylon
PMO: Polypropylene

Needlefelt
PE: Polyester
PO: Polypropylene
NY: Nylon

PEMO: Polyester
PTMO: ETFE

HT: Nomex®
PT: PTFE
W: Wool

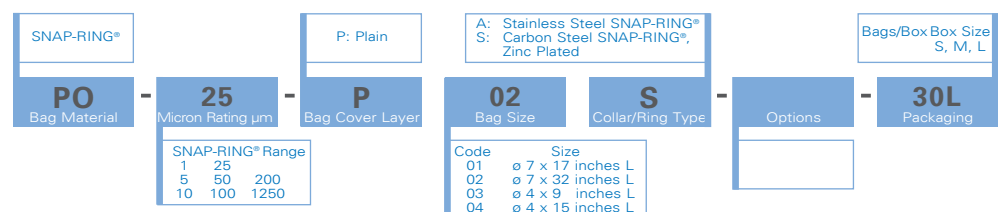

HAYFLOW™

Revolutionary New Filter Element

HAYFLOW™ Filter Element – The Next Generation of Filtration Systems



The concentric media layers are welded onto a top and a bottom ring

This new, patent pending filter element has combined the best of both bag and cartridge filters into one single filtration element for outstanding filtration performance. Because the surface area of the HAYFLOW element is up to 70% greater than a similar size filter bag, existing systems that use it experience longer filter element life and less changing, resulting in reduced running costs. Designers of new bag filtration systems can opt for reduced running costs or, because of the high flow rates possible with HAYFLOW filter element, reduce filter housing size by up to 50% thus lowering the initial cost of the system.

What Makes the HAYFLOW™ Element Better

The heart of a HAYFLOW filter element is two concentric cylinders of high-quality extended life Eaton filter media. These cylinders are formed using unique welding technology to create a no by-pass seam. The diameter of the cylinder is the same size as a standard filter bag, so retrofitting into existing systems is easy. The HAYFLOW element is fitted with the SENTINEL® sealing ring, ensuring a positive seal with the filter vessel to protect against bypass of the process media.

How the HAYFLOW™ Element Works

The process fluid enters the inside of the element, passes through it, and exits through the vessel outlet. Like a filter bag, the filtered-out material stays inside the HAYFLOW element. The HAYFLOW element is unlike a filter cartridge, where the residue of the filtered material remains on the outside of the cartridge, complicating the changing process.

An All-Around Better Choice

Changing a HAYFLOW filter element can actually be easier than changing a filter bag, because of its revolutionary design only retains 25% of the residual liquid volume of a similarly sized filter bag. When you need to change the element, it weighs up to 75% less than a filter bag. A full bag can weigh up to 33 lbs, so weight is an important consideration for the system operator.

NOMINAL RATED

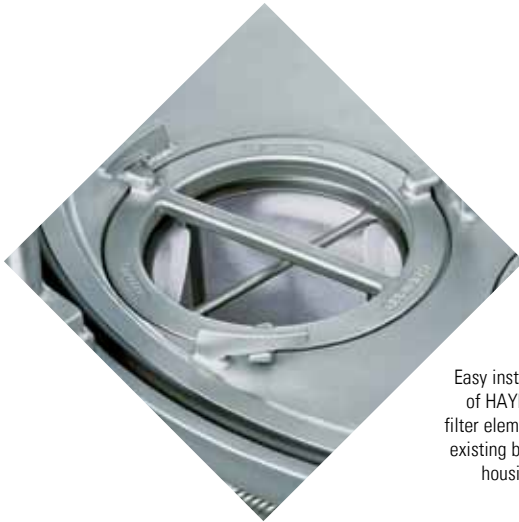
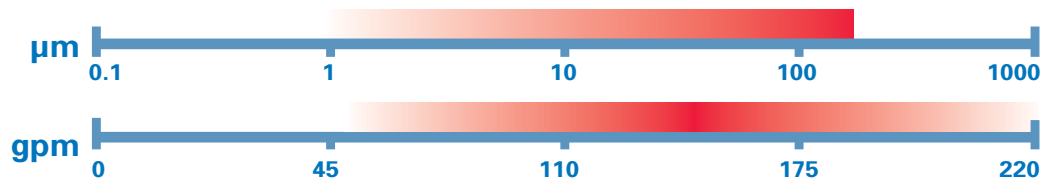

Easy installation of HAYFLOW filter elements into existing bag filter housings



The Choice is Yours

HAYFLOW filter elements can be adapted to a wide range of applications through the use of different filter media. Basically, any weldable filtration media can be used to construct a HAYFLOW element. Multilayered construction is also possible for applications that require it. Using melt-blown polypropylene media, HAYFLOW elements are available with high micron retention ratings, and with selective absorption characteristics as well. Standard HAYFLOW filter elements are available in both polypropylene and polyester construction. These two materials are very versatile and will perform in a majority of applications over a wide range of temperatures. HAYFLOW elements use a high-quality, extended life DURAGAF™ needle felt media with extremely fine fibers and higher pore volumes for superior performance. Both feature either polypropylene or polyester SENTINEL sealing rings.

The lower retention volume of the HAYFLOW element means less saleable product has to be thrown away. This important feature can provide considerable savings over time. It's cylindrical construction offers strength unrivaled in other similar products. The all-welded filter element is fit to a matching restrainer basket, allowing the filtration media to be replaced easily and quickly. The close-tolerance fit of the filter and the restrainer basket provide ease of installation and worry-free performance. This combination of fully-welded seams and a rigid, cylindrical geometry provides strength over a full range of operating differential pressure. The HAYFLOW element is always smooth and fits to the basket walls without crimps or pleats, guaranteeing a quick and easy installation. Batch system operators often do not want to stop a batch process and change a filter bag. Using HAYFLOW elements, system operators have found up to 5 times the life over a similar size filter bag and experienced reduced operating costs.

Usually, bag filters are bigger than cartridge filters but are easier to handle and more cost effective. HAYFLOW elements brings the best of both systems together...high flow rates in compact vessels, or a longer lifetime and extended changing cycles. HAYFLOW elements combine highly efficient filter media, enlarged surface area, better dirt-holding capabilities and a reduction of the residual liquid volume retained in the element. All of these advantages result in superior filtration performance.

Cutaway of the element from an E-coat tank filtration after being in service for eleven weeks



Metal fines collected from parts washer

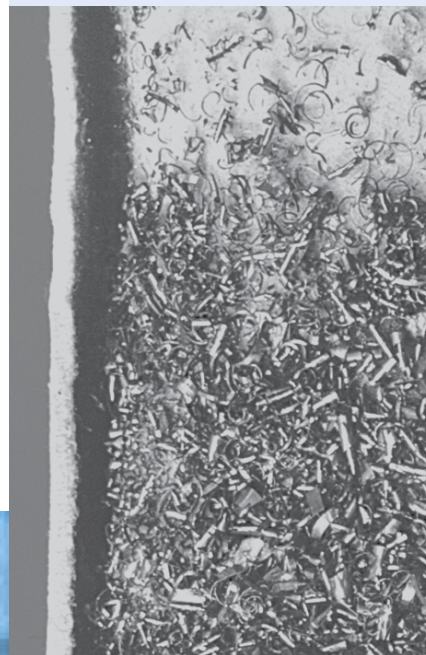

HAYFLOW™

The HAYFLOW Effect

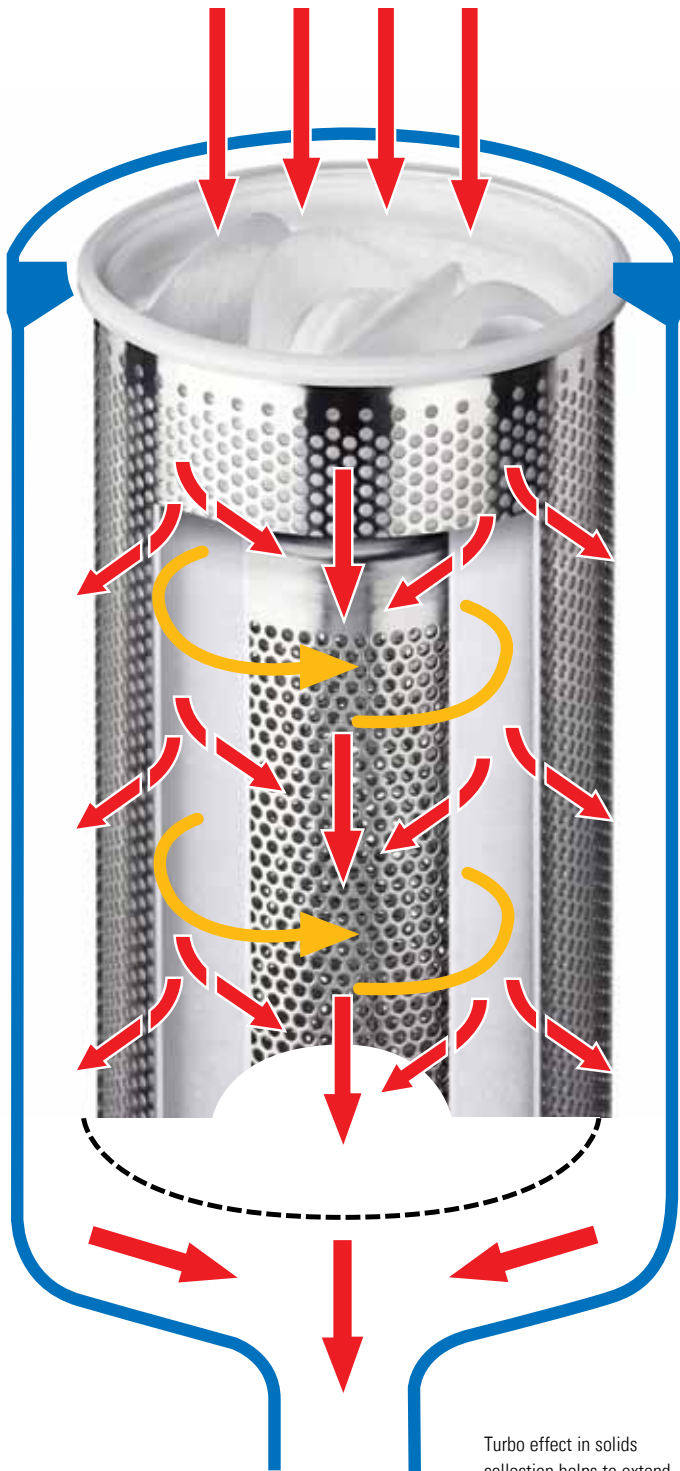

Turbo effect in solids collection helps to extend life of filter element

Features:

- Higher flow rates - smaller, less costly housings can be used
- Up to five times greater life over filter bags
- Liquid losses are 25% of similar size filter bag
- SENTINEL sealing ring and 100% welded construction for no by-pass
- Up to 35 times more effective than standard filter cartridges
- Low pressure differential results in less energy consumption of pumps
- Very cost-effective in comparison to similar systems
- Rugged cylindrical construction
- Easier maintenance with reduced costs
- Easy retro fit to existing filter housings

And...Eaton's superior support, before, during and after system installation.

Take Advantage of HAYFLOW™ Elements Now

You can easily change over from ordinary bag filtration to the revolutionary new HAYFLOW filter element. Existing bag filter housings need only to be fitted with a new HAYFLOW restrainer basket for instant compatibility with the HAYFLOW element. No tools, special equipment or modification to the vessel are required. Just drop in the new basket, and you are ready to take advantage of all the benefits offered by a HAYFLOW filtration system.

Still Not Sure if HAYFLOW™ Filter Element is Right for You?

Contact us. We can show you how you can save money and improve your filtration process using HAYFLOW filter elements.

HAYFLOW™

Application:

- ✓ Automotive
- ✓ Sugar Processing
- ✓ Paints, Coatings, Inks, Dispersions
- ✓ Resins
- ✓ Water and Waste Water Treatment
- ✓ Solvents
- ✓ Lubricants and Metalworking Fluids
- ✓ Aqueous and Solvent Based Cleaners in Parts Washing Equipment
- ✓ Pulp and Paper
- ✓ Oil and Gas Exploration and Processing
- ✓ Pharmaceutical
- ✓ Food Processing
- ✓ Chemical Process Industries
- ✓ Potable Water, Beer, and Wine
- ✓ Edible Oils

Remember "Filter Cost" and "Filtration Cost" are Not the Same Thing

We can explain the difference and demonstrate the HAYFLOW filter element advantage in your application.



PRODUCT CODES

HAYFLOW™

POXL: Polypropylene Extended Life Needlefelt
PEXL: Polyester Extended Life Needlefelt
LCR: LOFCLEAR™

POXL
Material

1

Micron Rating µm

1, 5, 10, 25, 50,
100 (POXL/PEXL)
128 (LCR)

HAY

Filter Element
HAYFLOW
7 x 28 inches

08L

Packaging

Elements/Box Box Size
8 L (large)



EATON PRECISION

PRODUCT LINE	Media	μ-Ratings																	
		1	5	10	25	50	80	100	125	150	200	250	300	400	600	800	1000	1250	
PROGAF™	PGF	50	51	55	57														
ACCUGAF™	AGF AGFE	51 51	53	55 55	57 57	59													
LOFCLEAR™	LCR	123 130 522	124 135	125 525	126 527	128	129												
CLEARGAF™	POF PEF POXLF PEXLF NMOF							x	x	x	x	x							
DURAGAF™	POXL PEXL							x	x	x	x	x							
SENTINEL®	PO PE NMO							x	x	x	x	x							
SNAP-RING®	PO PE NY HT PT W NMO PMO PEMO PTMO PEMU							x	x	x	x	x							
BANDSEAL™	NMO																		
HAYFLOW™ (special basket required)	POXL PEXL LCR					128		x	x	x	x	x							

FILTER BAGS

Available Size / Maximum Flow (gpm)							Rings			Weld/Sewn			Media			Max op. Temp (°F)
01	02	03	04	43	45	SENTINEL	SNAP-RING	Band	Ring	Side	Bottom	Material	Type	Surface Finish		
	45					E			W	W	W	Polypropylene	Meltblown		194	
35	66					E			W	W	W	Polypropylene	Meltblown		194	
35	66					H			W	W	W	Polyester	Meltblown		302	
35	66					E			W	S	S	Polypropylene	Meltblown		194	
						E			W	S	S	Polypropylene	Meltblown		194	
	53					Z			W	W	W	Polypropylene	Meltblown		194	
90	180					E			W	W	W	Polypropylene	Felt	singed	194	
90	180					Z			W	W	W	Polyester	Felt	singed	284	
75	135					E			W	W	W	Polypropylene	Felt	glazed	194	
75	135					Z			W	W	W	Polyester	Felt	glazed	284	
90	180					Z			S	S	S	Nylon	Mesh		284	
75	135					E			W	W	W	Polypropylene	Felt	glazed	194	
75	135					H			W	W	W	Polyester	Felt	glazed	302	
90	180	26	53			E			W	W	W	Polypropylene	Felt	singed	194	
90	180	26	53			H			W	W	W	Polyester	Felt	singed	302	
90	180	26	53			Z			S	S	S	Nylon	Mesh		257	
90	180	26	53				S		S	S	S	Polypropylene	Felt	singed	230	
90	180	26	53				S		S	W	S	Polyester	Felt	singed	374	
90	180	26	53				S		S	S	S	Nylon	Felt		374	
90	180						A		S	S	S	Nomex®	Felt	singed	390	
90	180						A		S	S	S	PTFE	Felt		500	
90	180						S		S	S	S	Wool	Felt		275	
90	180	26	53				S		S	S	S	Nylon	Mesh		374	
90	180						A		S	S	S	Polypropylene	Mesh		230	
90	180						S		S	S	S	Polyester	Mesh		374	
90	180						A		S	S	S	ETFE	Mesh		300	
90	180						S		S	S	S	Polyester	Mesh		293	
90					6	12			R	S	S	Nylon	Mesh		374	
									S	S	S	Nylon	Mesh		374	
	180						E		W	W	W	Polypropylene	Felt	glazed	194	
	180						H		W	W	W	Polyester	Felt	glazed	302	
	180						E		W	S	W	Polypropylene	Meltblown		194	

TECHNICAL INFORMATION

U.S. Mesh	Inches	Microns	U.S. Mesh	Inches	Microns
3	0.265	6730	45	0.0138	354
3-1/2	0.223	5660	50	0.0017	297
4	0.187	4760	60	0.0098	250
5	0.157	4000	70	0.0083	210
6	0.132	3360	80	0.0070	177
7	0.111	2830	100	0.0059	149
8	0.0937	2380	120	0.0049	125
9	0.0787	2000	140	0.0041	105
10	0.0661	1880	170	0.0035	88
12	0.0555	1410	200	0.0029	74
14	0.0469	1190	230	0.0024	63
18	0.0394	1000	270	0.0021	53
20	0.0331	841	325	0.0017	44
25	0.0280	707	400	0.0015	37
30	0.0232	595	550	0.0009	25
35	0.0197	500	800	0.0006	15
40	0.0105	420	1250	0.0004	10

◀ Comparative Particle Size

Filter Bag Specifications

Bag Size	Max Flow Water (gpm)	Flow Area (sq.ft.)	Volume (gal.)	Diameter (in.)	Length (in.)
01	90	2.6	2.0	7	17
02	180	5.0	4.5	7	32
03	25	0.8	0.5	4	8
04	50	1.5	0.7	4	14
05	75	2.1	1.0	4	20
43	25	1.0	0.8	3.5	12
45	50	1.6	1.2	3.5	20

Chemical & Thermal Resistance of Filter Bags

Filter Media	Abbreviation	Temp. °F	Temp. °C	Aqueous Media	Aliphatic Solvents	Aromatic Solvents	Alkaline Systems	Strongly Alkaline	Acid Systems	Strongly Acidic
Polypropylene Felt	PO/POXL/POF/POXLFL	200	93	●	●		●		●	●
Polyester Felt	PE/PEXL/PEF/PEXFL	300	149	●	●	●	●		●	
Nylon Felt	NY	325	163	●	●	●	●	●		
High Temp. Nomex Felt	HT	400	204	●	●	●	●		●	
Polyester Multifilament	PEMU	300	149	●	●	●	●		●	
Polypropylene Monofilament	PMO	200	93	●	●		●		●	
Nylon Monofilament	NMO	325	183	●	●	●	●	●		
PTFE	PT	500	260	●	●	●	●	●	●	

SSU (Saybolt Seconds Universal)	Centipoise	Engler Degrees 20°C	Redwood Standard
30	1	-	-
50	5	2	44
100	20	3.5	88
200	40	16	175
300	65	30	263
400	85	43	350
500	105	57	440
600	130	72	525
700	150	90	615
800	175	115	700
900	195	132	790
1000	210	150	880
2000	425	350	1750
3000	625	540	2600
4000	860	740	3500
5000	1050	930	4550
6000	1300	1120	5250
7000	1500	1320	6150
8000	1700	1510	7300
9000	1920	-	-
10000	2150	-	-

Viscosity Equivalents

Flow Conversion Factors

M ³ /hr = 3.671 I.G.M.
I.G.P.M. = 41.14 Barrels/Day
T.P.H. = 3.74 I.G.M.
I.G.P.M. = 1.2 U.S. G.P.M.
I.G.P.M. = 4.54 Liters/Min
LITER/MIN = 0.22 I.G.P.M.
U.S. G.P.M. = 0.833 I.G.P.M.
Barrel = 35 Imp. Gallons
Barrel = 42 U.S.Gallons

Volume Conversion Factors

To Obtain: Multiply By:	U.S. Gallon	Imperial Gallon	U.S. Pint	U.S.Pound Water	U.S. Cubic Foot	U.S. Cubic Inch	Liter	Cubic Meter
U.S. Gallon	1	0.833	8.0	8.337	0.13368	231.0	3.78533	0.003785
Imperial Gallon	1.2009	1	9.60752	10.0	0.16054	277.42	4.54596	0.004546
U.S. Pint	0.125	0.1041	1	1.042	0.01671	28.875	0.473168	0.000473
U.S. Pound Water	0.11995	0.1	0.9596	1	0.016035	27.708	0.45405	0.00454
U.S. Cubic Foot	7.48052	6.22888	59.8442	62.365	1	1728.0	28.31702	0.028317
U.S. Cubic Inch	0.004329	0.00361	0.034632	0.03609	0.0005787	1	0.016387	0.0000164
Liter	0.2641779	0.2199756	2.113423	2.202	0.0353154	61.02509	1	0.001
Cubic Meter	264.170	219.969	2113.34	2202	35.31446	61023.38	1000	1

Pressure Conversion Factors

To Obtain: Multiply By:	Pound Sq. In.	Pound Sq. Ft.	Atmosphere	Kilogram Sq. Cm.	Inch Water	Foot Water	Inch Mercury	mm Mercury	Bar
Pounds/Sq. In	1	144.0	0.068046	0.070307	27.7276	2.3106	2.0360	51.7150	0.06895
Pounds/Sq. Ft.	0.0069545	1	0.000473	0.000488	0.1926	0.01605	0.014139	0.35913	0.000479
Atmosphere	14.696	2116.22	1	1.0332	407.484	33.9570	29.921	760.0	1.01325
Kilogram/Sq. Cm.	14.2233	2048.16	0.96784	1	394.27	32.864	28.959	735.558	0.9807
Inch Water	0.03607	5.194	0.002454	0.00254	1	0.08333	0.0734	1.865	0.00249
Foot Water	0.43278	62.3205	0.029449	0.03043	12.0	1	0.8811	22.381	0.02984
Inch Mercury	0.49115	70.726	0.033421	0.03453	13.617	1.1349	1	25.40	0.03386
mm Mercury	0.019337	2.7845	0.0013158	0.0013595	0.5361	0.04468	0.03937	1	0.001333
Bar	14.5038	2088.55	0.98692	1.0197	33.51	402.1	29.53	750.0	1

**Eaton
North America – HQ**

44 Apple Street
Tinton Falls, NJ 07724

Toll Free: (800) 656-3344
(North America only)

Voice: (732) 767-4200
Fax: (952) 906-3706

**Eaton
Europe/Africa/Middle East**

Auf der Heide 2
53947 Nettersheim
Germany

Voice: +49-2486-809-0
Fax: +49-2486-809-800

**Eaton
Brazil**

Av. Julia Gaioli, 450 –
Bonsucesso
07250-270 – Guarulhos
Brazil

Voice: +55 (11) 6465-8780
Fax: +55 (11) 6480-2808

**Eaton
China**

No.3, Lane 280, Linhong Road
Changning District, 200335
Shanghai, P.R. China

Voice: 86-21-5200-0099
Fax: 86-21-5200-0400

**Eaton
Singapore**

4 Loyang Lane #04-01/02
Singapore 508914

Voice: +65-6825-1668
Fax: +65-6825-1639

©2011 Eaton Corporation. All Rights Reserved.
All trademarks and registered trademarks are the
property of their respective owners. Printed in
the USA.

*For more information,
please e-mail us at
filtration@eaton.com,
or call 732-767-4200.*

*Visit us online at
filtration.eaton.com for a
complete list of Eaton's
filtration products.*

All information and recommendations appearing in this brochure concerning the use of products described herein are based on tests believed to be reliable. However, it is the user's responsibility to determine the suitability for his own use of such products. Since the actual use by others is beyond our control, no guarantee, expressed or implied, is made by Eaton as to the effects of such use or the results to be obtained. Eaton assumes no liability arising out of the use by others of such products. Nor is the information herein to be construed as absolutely complete, since additional information may be necessary or desirable when particular or exceptional conditions or circumstances exist or because of applicable laws or government regulations.

GAF®, the GAF® logo, ACCUGAF®, DURAGAF®, PROGAF®, and GAF SNAP RING® are registered trademarks of GAF Corporation in the United States and are used under license. HAYWARD FILTRATION® is a trademark owned by and used with permission of Hayward Industrial Products, Inc.



Powering Business Worldwide